



Gayatri Vidya Parishad College of Engineering for Women.

MADHURAWADA, VISAKHAPATNAM, 530048.

(AFFILIATED TO JNTU KAKINADA, APPROVED BY AICTE, NEW DELHI)

Department of Electrical and Electronics Engineering.

Vidyut-2K20

...the electrical magazine



Issue-4

THE REAL POTENTIAL OF ELECTRICITY LIES
NOT IN PROVIDING SOCIAL AMENITIES,
BUT IN STIMULATING LONG-TERM
ECONOMIC DEVELOPMENT...

INDEX

- Director's Message.....03
- Principal's Message04
- HOD'S Message.....05
- Editorial..... 06
- Vision, Mission, PEO,PSO07
- Know a scientist..... 08
- Faculty Article..... 09
- Student Article..... 17
- Technology Review.....23
- Department Activities31
- Student Activities 32
- Student Corner 36
- Editorial Board Members..... 45

DIRECTOR'S MESSAGE



I am very much delighted and pleased to know that the College is bringing out a Magazine with good and useful information on Engineering and Technology and also the available infrastructure and facilities provided for the benefit of students and Faculty.

The efforts by the faculty and students to bring out this magazine with a beautiful getup needs a good word of appreciation. I wish this would continue in future too which certainly upholds the academic environment and decorum of this campus. Let me thank all the senior teachers and the other faculty who had shared their experiences by their rich and highly informative contributions to the Magazine.

As I embark upon my journey as the Principal for Gayatri Vidya Parishad College of Engineering for Women, I am jubilant to meet through this page which is a driving force for the students and faculty at GVPCEW to be proactive towards learning. As we try to prepare the students always to "Think and Review" so as to discover the cause and effect of every event, would surely reveal the hidden talents of the academic fraternity. It gives me immense pleasure to encapsulate yet another occasion of success. I congratulate everyone who endeavours towards our cherished motto of empowering the students for all round development through technical education. Thorough acquisition of knowledge fringed with skills required and character building is our promise by providing necessary resources and resourceful intelligentsia ensuring expected settlement.

PRINCIPAL MESSAGE



I am very much delighted and pleased to know that the College is bringing out a Magazine with good and useful information on Engineering and Technology and also the available infrastructure and facilities provided for the benefit of students and Faculty.

The efforts by the faculty and students to bring out this magazine with a beautiful getup needs a good word of appreciation. I wish this would continue in future too which certainly upholds the academic environment and decorum of this campus. Let me thank all the senior teachers and the other faculty who had shared their experiences by their rich and highly informative contributions to the Magazine. I am a staunch believer that the actions speak more than the words and that everybody must keep his promises to discharge duties as a responsible person of the society.

My hearty congratulations to all those concerned in planning, organizing and bringing out this colourful product which I believe, keeps this college in the limelight amongst all the institutions in and around Visakhapatnam.

Our progressive management looks forward and wishes that our institute raises to the occasion by standing in the privileged front row. Steps are being taken in this direction and fruits of these efforts will be shared by our students in the near future.

HOD'S MESSAGE



The G.V.P. College of Engineering for Women is facilitating such a nice platform to the students of all branches to prove themselves and enrich their knowledge. Hope that each participant will enjoy the academic flavours of all programs and gain high confidence levels. I wish the program to be a grand success.

EDITORIAL

Educational institutions are the "temples of learning" in parlance of great thinkers. It is institutions which create individual values as contributing citizens of India.

Profession of Engineering is old as human life is yet to be synchronized globally thereby giving deserved respectability to the engineer. It is in this direction much work needs to be done through continuous productive interactions between institutions, industrial associations and global regulatory bodies.

It is interesting to learn about the institution's services rendered in shaping lives of youngsters who arrive as raw individuals at the portals of this institution. Deep rooted conviction of management combined with dedicated faculty has made us stand out as an institution of reckoning for the past 10 years. Our best wishes to every member of the team for making expressions become the much awaited magazine of Indian fraternity.

We are happy to bring out the issue of "VIDYUT" for the year 2020. In this issue the faculty article is on **'TWO STAGE MULTIPLE INPUT TRANSFORMERLESS PHOTOVOLTAIC MULTILEVEL INVERTER WITH INDIVIDUAL MPPT'** by Dr. A.Hemachander, who has explained about the transformer less grid-connected photovoltaic multilevel inverter for realizing individual maximum power point of each module. There are two student articles one on **"Comparison Of Charging Technologies For Electric Vehicle Battery Charging"** and the other on **"Energy Audit - A Case Study of an Institutional Building"**. The articles have described the concepts relating to the latest technologies in the field of Electrical engineering. This is followed by the regular sections of Technology Review; Know a Scientist, Short Story and Puzzles, Arts. This issue also contains the contributions and achievements of the students and faculty of the department during the year. We are thankful to the entire department for their continuous support in bringing this issue successful.

VISION

To develop into a centre of learning that empowers students with contemporary knowledge in Electrical and Electronics Engineering.

MISSION

- Impart skills both in traditional and modern areas of Electrical & Electronics Engineering
- Provide exposure to latest developments in the field through Seminars, Industrial visits, Workshops and Paper presentations.
- Prepare the young minds to apply professional engineering practices by considering environmental and societal needs.

PROGRAM EDUCATIONAL OBJECTIVES

After successful completion of the program, the graduates will be able to:

- PEO-1: Possess a strong educational foundation in mathematics, science, electrical engineering and soft skills in the diversified sectors of the industry.
- PEO-2: Exhibit critical thinking, problem-solving skills, and design systems in professional engineering practice.
- PEO-3: Establish leading and supportive positions in society by adopting lifelong learning skills with a commitment to their ethical and social responsibilities.

PROGRAM SPECIFIC OUTCOMES

Engineering Graduates will be able to:

PSO-1: Design and analyze systems that efficiently generate, transmit, distribute and utilize electrical power.

PSO-2: Demonstrate proficiency in the use of hardware and software tools for solving the complex engineering problems in renewable energy and other emerging areas.



Alessandro Giuseppe Antonio Anastasia Volta (Italian: [ales'sandro 'volta]; 18 February 1745 – 5 March 1827) was an Italian physicist, chemist,

and pioneer of electricity and power who is credited as the inventor of the electric battery and the discoverer of methane. He invented the Voltaic pile in 1799, and reported the results of his experiments in 1800 in a two-part letter to the President of the Royal Society. With this invention Volta proved that electricity could be generated chemically and debunked the prevalent theory that electricity was generated solely by living beings. Volta also drew admiration from Napoleon Bonaparte for his invention, and was invited to the Institute of France to demonstrate his invention to the members of the Institute. Volta enjoyed a certain amount of closeness with the emperor throughout his life and he was conferred numerous honours by him. Volta held the chair of experimental physics at the University of Pavia for nearly 40 years and was widely idolised by his students.

Despite his professional success, Volta tended to be a person inclined towards domestic life and this was more apparent in his later years. The SI unit of electric potential is named in his honour as the volt.

Career and Contributions:

In 1774, he became a professor of physics at the Royal School in Como. A year later, he improved and popularised the electrophorus, a device that produced static electricity. His promotion of it was so extensive that he is often credited with its invention, even though a machine operating on the same principle was described in 1762 by the Swedish experimenter Johan Wicked. In 1777, he travelled through Switzerland. There he befriended H. B. de Saussure.

In the years between 1776 and 1778, Volta studied the chemistry of gases. He researched and discovered methane after reading a paper by Benjamin Franklin of the United States on "flammable air". In November 1776, he found methane at Lake Maggiore, and by 1778 he managed to isolate methane. He devised

Experiments such as the ignition of methane by an electric spark in a closed vessel.

Volta also studied what we now call electrical capacitance, developing separate means to study both electrical potential (V) and charge (Q), and discovering that for a given object, they are proportional. This is called Volta's Law of Capacitance, and for this work the unit of electrical potential has been named the volt. Volta carried out his experimental studies and produced his first inventions near Como.

In 1779 he became a professor of experimental physics at the University of Pavia, a chair that he occupied for almost 40 years.

Awards and Honours:

In 1809 Volta became associated member of the Royal Institute of the Netherlands. In honour of his work, Volta was made a count by Napoleon Bonaparte in 1810.

Volta's legacy is celebrated by the Tempio Voltiano memorial located in the public gardens by the lake. There is also a museum which has been built in his honour, which exhibits some of the equipment that Volta used to conduct experiments. Nearby stands the Villa Olmo, which houses the Voltian Foundation, an organization promoting scientific activities. His image was depicted on the Italian 10,000 lire note (1990–1997) along with a sketch of his voltaic pile.

In late 2017, Nvidia announced a new workstation-focused microarchitecture called Volta, succeeding Pascal and preceding Turing. The first graphics cards featuring Volta were released in December 2017, with two more cards releasing over the course of 2018. . Volta retired in 1819 to his estate in Camnago, a frazione of Como, Italy, now named "Camnago Volta" in his honour. He died there on 5 March 1827, just after his 82nd birthday. Volta's remains were buried in Camnago Volta.

Two Stage Multiple Input Transformerless Photovoltaic Multilevel Inverter with Individual MPPT Realization

Dr.Allamsetty Hemachander
 Assistant Professor
 EEE Department

Abstract— In this paper, a transformer less grid-connected photovoltaic multiple level inverter for realizing individual maximum power point (MPP) of each module has been presented. The presented configuration is simple and modular, providing flexibility to increase the number of inputs with less component count. The systematic procedure for designing the controller has been detailed. The presented converter and the controller design allow the system to operate with the dedicated MPP and simultaneously achieve the load demand while maintaining the desired grid voltage. This has been verified under different operating scenarios in the MATLAB environment. The leakage current and the common mode voltage have been analyzed to verify its suitability for grid-connected systems.

Keywords— MPPT, transformer less inverter, multilevel inverter, photovoltaic

INTRODUCTION

The grid-connected solar photovoltaic (PV) systems throughout the globe tremendously support the generation system to meet the energy demand. In most of the developing countries, rooftop/ residential single-phase photovoltaic systems connected to the grid are gaining high popularity [1]. Power converters with transformer less operation have been gaining importance for integrating the rooftop/residential systems to the grid. The classical topological structure relates to a single-phase centralized transformer less inverter [2–5] with a string of PV modules connected to the centralized inverter without a transformer. Two-stage conversion topologies with the initial DC/DC conversion followed by DC/AC conversion has been proposed in the literature with the transformer less operation. For instance, the inverting stage may comprise of buck-type as H-5, HERIC, H6 or buck-boost type [5, 6]. Due to higher efficiency and low cost, the family of string inverters has been commercialized on a larger scale. However, these topologies do not possess maximum power Point tracking (MPPT) of individual modules resulting in a substantial power loss during partial shading conditions [2].

Numerous module based topologies with individual MPPT capability have been proposed for PV application [2,7–9] with series and parallel structures as illustrated in Fig.1. For instance, structures proposed in [10–12] eliminates the DC/DC conversion stage and all the DC/AC converters in the string are connected in series. The series connections have been effective in achieving the individual MPPT, however, possess the high voltage DC arc fault [13,14]. To avoid this, parallel structures have been proposed [2,9,15,16]. Despite the series and parallel operation of converter structures, a topology having isolated DC/AC inverter connected to the module is proposed in [2,17,18] which is termed as micro inverter. Besides the mentioned structures, interleaved structures have also proved to be efficient for harvesting maximum power from individual modules [17] but possess increased size and cost.

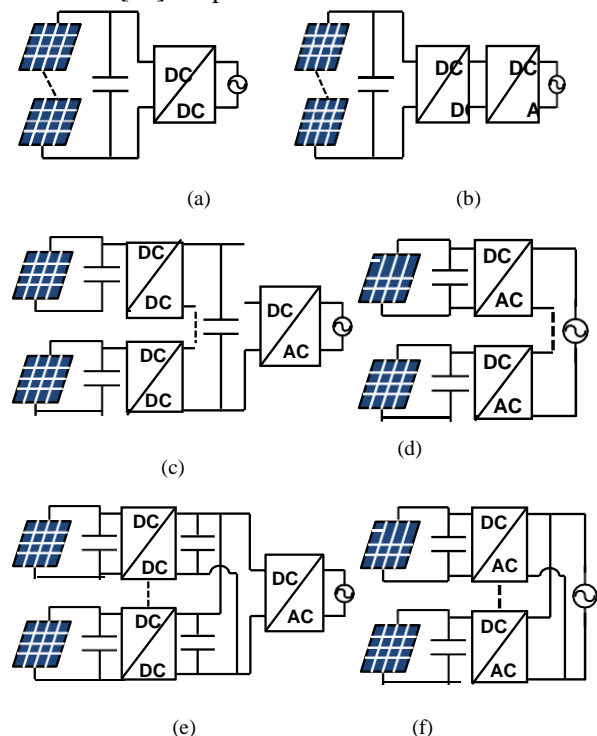

Fig.1. Classical Single phase transformerless PV inverters (a) single stage (b) two stage (c) series connected two stage (d) series connected single stage (e) parallel connected two stage (f) parallel connected single stage

Recent times have witnessed the improvement in transformer less multilevel inverter (MLI) topologies in which cascaded H-bridge (CHB) MLIs have been widely established. A CHB with two modules, each achieving MPPT has been proposed in [10–12] with limitations on a maximum number of modules which limits the flexibility

For residential applications. To overcome this, a structure with improved flexibility has been proposed using quasi Z-source configuration and connecting it in CHB [19,20]. However, the additional diodes and the inductors result in decreased efficiency.

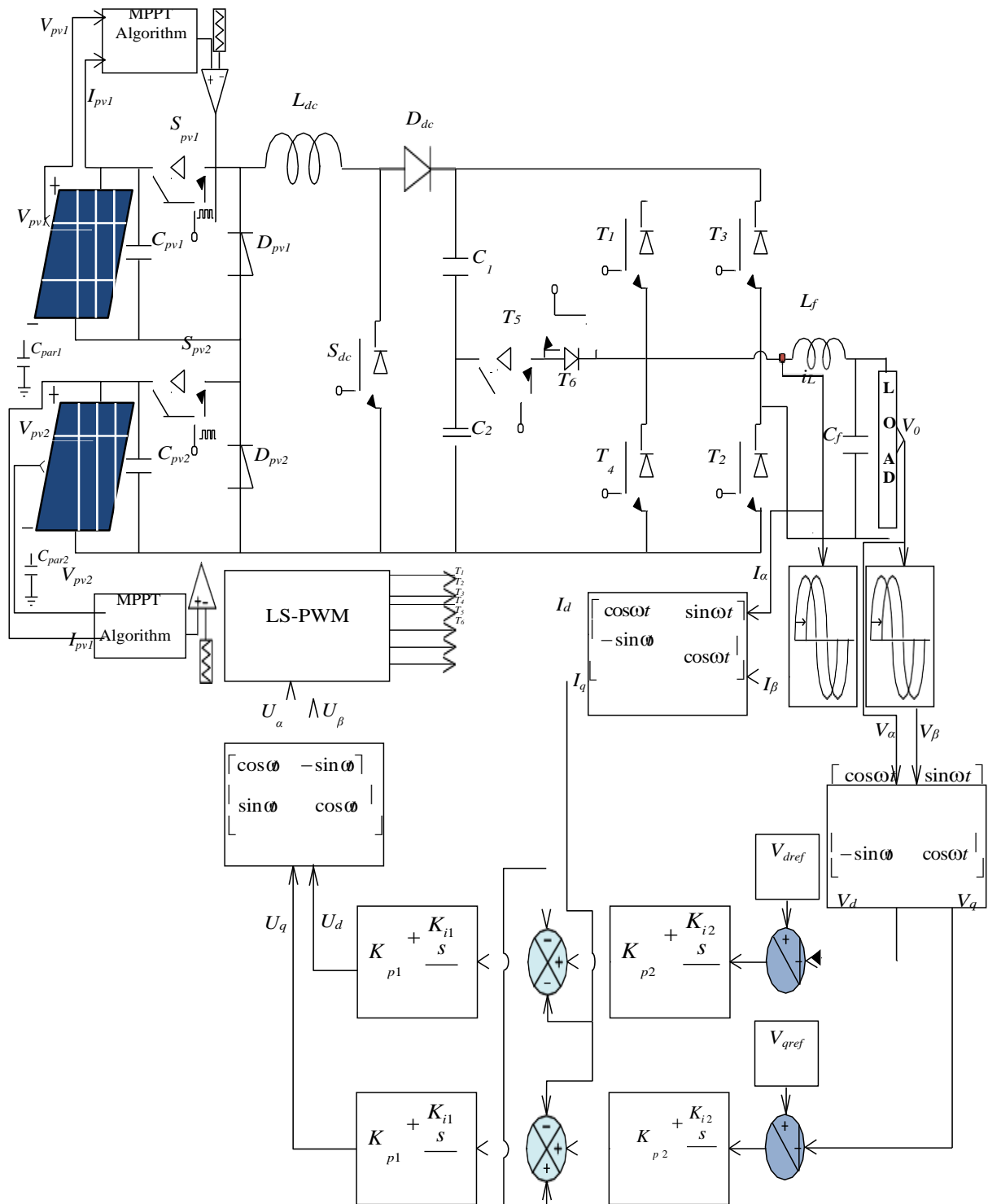

Fig.2. Schematic of the proposed configuration with control structure

To increase the system voltage, a buck-boost based single phase CHB followed by an AC boost converter is proposed in [21]. This topology possesses the advantage of high modularity, however, cannot realize the individual MPPT of the modules. To minimize the device count and voltage stress in CHB inverters, T-type MLIs have been gaining importance in recent times for commercial applications [22–25]. The state of art discussed several single stage and two-stage inverter configurations. The single stage transformer less MLI structures possess low component count and simple structure, however, employs a complex control circuitry for MPPT tracking and voltage regulation. On the other hand, most of the two-stage transformer less MLI structures proved to realize individual MPPT effectively.

A module based single-phase transformer less MLI for low/medium power PV system is presented in this paper. The configuration provides flexibility to increase the number of modules connected and has less component count. The proposed structure involves two-stage conversion in which the DC/DC conversion stage involves a non-isolated converter followed by a T-type MLI. The proposed converter and controller design allows the system to operate with the dedicated MPP and simultaneously achieve the load demand while maintaining desired grid voltage. In addition, leakage currents and the common mode voltage plays a vital role in reducing the electromagnetic interferences to verify the suitability of the presented structure for grid-connected systems. The rest of the paper is organized as follows. Section II briefs the system configuration followed by the control strategy in Section III. The systematic design of the controller is discussed in Section IV followed by the simulation results and their discussion in Section V. Finally, section VI concludes the paper.

SYSTEM CONFIGURATION

The proposed system for the realization of individual MPPT with the controller is depicted in Fig.2. Each module is connected to a switch in series for MPPT of each PV module and a diode, which bypasses the module when not in operation. The conventional boost converter connected to this enhances the voltage level. The arrangement is further connected to a T-type MLI for five level voltage generations and then connected to the grid through the filter. It is a well-known fact that MLIs reduce the harmonics and thus size and cost of the filter. The design parameters of the system are listed in Table I. The sources can be operated either simultaneously or individually. The simultaneous operation results in a series connection of the modules that make them operate at common MPP. To avoid such scenarios,

Time multiplexing switching scheme has been implemented. The inductor L_{oc} , switch S_{dc} and diode D_{dc} form the conventional boost converter for voltage step-up. The DC/AC conversion using T-type MLI,

as mentioned reduces the filter requirements to minimize the switching stress thus enhances the reliability of the converter. The level shifted pulse width modulation (LS-PWM) is employed for inherent capacitor voltage balancing.

TABLE I Design Parameters

Parameter	Value	Parameter	Value
L_{dc}	2.5 mH	L_f	1 mH
C_1	660 μ F	C_f	1200 μ F
C_2	660 μ F	f_s	10 kHz

CONTROL STRATEGY

The control technique of the presented system is categorized as MPPT control and Inverter Control. The MPPT control aims in realizing MPPT of individual modules and the inverter control aims at grid voltage regulation.

MPPT Control

To operate each module at individual MPP during partial shading and further to avoid the series operation of the PV modules, the structure is operated with the time multiplexing switching scheme. Owing to the advantages like simple, easier implementation with less computational efforts, the classical perturb and observe (P&O) method is employed for MPPT operation [26].

Inverter Control

A pre-defined voltage is desired on the AC side for effective load operations. Numerous inverter control techniques have been discussed in the state of art for load voltage regulation. Few of them relates to dead beat control [27], repetitive control [28] and sliding mode control [29] which have gained high popularity due to their better dynamic performance. In addition, they also give faster response and can prevent overshoot and ringing if properly designed. However, these are highly sensitive, complex and moreover do not give zero steady-state error [30,31]. Synchronous reference frame (SRF) controller exhibits zero steady-state error while achieving improved dynamic performance [32,33]. The SRF based PI controller is well established in three-phase systems; however, very limited literature is available for application of SRF-PI method for single phase systems. Owing to the advantage of zero steady-state error, an attempt has been made to use this method for proposed grid-connected T-type inverter voltage control. A PLL is employed and regulated for grid frequency control.

1. Generation of OrthogonalPhase:

In three-phase systems, three signals are available for conversion into $d-q$ coordinates using Park's transformation. However, an orthogonal phase is necessary for single phase systems to provide the $d-q$ frame. Several methods like providing a delay to the original signal [34], differentiating the original signal [35], Hilbert transform [36], second-order generalized transform integrator [37], Kalman filter method [37] and all pass method [38] have been proposed for orthogonal signal generation. For easier implementation, a delay to the original signal is implemental and validated for

proposed converter control. Thus, the original signal along with generated orthogonal signal is used for conversion from $\alpha\beta$ frame to dq frame.

2. Control Structure:

The implemented control structure for regulation of output voltage is depicted in Fig.2. The scheme consists of an SRFPI based controller for Instantaneous output voltage regulation. An inner Current control loop is provided for damping and improved transient response. In addition to the two loops, a voltage feed forward path provides the robustness of the system against the possible parameter variation. Implementing inner current loop includes sensing inductor current which can enable the inverter over current protection.

CONTROLLER DESIGN

Initializing with the orthogonal signal generation, the details of the controller design is followed below:

Step 1: An orthogonal signal (V_β) is generated from the available voltage signal (V_α).

$$V_\alpha = V_o \sin \omega t \quad (1)$$

$$V_\beta = V_o \sin(\omega t - 90) \quad (2)$$

Step 2: The synchronous reference frame ($\alpha\beta$) is converted to a stationary reference frame (dq) using

Park's transformation. The synchronous reference frame possesses the ability to eliminate the steady-state error by shifting fundamental frequency information back to DC and using conventional DC regulator such as PI controller. The Park's transformation in a single phase is given by

$$\begin{bmatrix} V_d \\ V_q \end{bmatrix} = \begin{bmatrix} \cos \omega t & \sin \omega t \\ -\sin \omega t & \cos \omega t \end{bmatrix} \begin{bmatrix} V_\alpha \\ V_\beta \end{bmatrix} \quad (3)$$

Step 3: The controller design for α -frame is discussed and the same is applied for controller design in β -frame. The open loop transfer function of the inner loop is given by

$$G_i(s) = \left(\frac{1}{s + \frac{L_f}{r}} \right) \left(\frac{K}{s + \frac{L_f}{r}} \right) \quad (4)$$

The magnitude of the transfer function at the gain cross over frequency is

$$|G_i(j\omega)| = 1 \quad (5)$$

$$\left| \frac{1}{s + \frac{L_f}{r}} \right| \left| K_{p1} + \frac{K_{i1}}{s} \right|_{s=j\omega_{BWI}} = 1 \quad (6)$$

where ω_{BWI} is the bandwidth of the inner loop, generally chosen to be one-tenth of the switching frequency (f_s) and is given by

$$\omega_{BWI} = \frac{1}{10} * 2\pi f_s \text{ rad / sec} \quad (7)$$

On substituting the converter parameters in (6), an optimization problem is formulated for which the objective function is given as

$$\min(f_i(K_{p1}, K_{i1})) = K_{p1} + (3.18 \times 10^{-4}) K_{i1} - 3.92 \quad (8)$$

The widely used evolutionary optimization technique, genetic algorithm (GA) is implemented to minimize f_i . The solution obtained [K_{p1} , K_{i1}] post convergence of GA is utilized as current controller parameters.

Step 4: The higher bandwidth setting of the inner loop provides faster response for possible current variations and allows to consider the transfer function of complete inner loop as unity while designing the outer voltage loop parameters. On the same lines as described in step 3, the transfer function is obtained from (9) and the objective function is formulated as (10).

$$\left| \frac{1}{C_s} \right| \left| K_{p2} + \frac{K_{i2}}{s} \right|_{s=j\omega_{BWO}} = 1 \quad (9)$$

where ω_{BWO} is the bandwidth of the outer voltage loop and is far less than ω_{BWI} , generally ω_{BWO} is less than one-third of ω_{BWI}

$$\min(f(K_{p2}, K_{i2})) = K_{p2} + (2.5 \times 10^{-4}) K_{i2} - 0.8 \quad (10)$$

Step 5: The quantities in dq -frame are converted to $\alpha\beta$ -frame as

$$\begin{bmatrix} V_\alpha \\ V_\beta \end{bmatrix} = \begin{bmatrix} \cos \omega t & -\sin \omega t \\ \sin \omega t & \cos \omega t \end{bmatrix} \begin{bmatrix} V_d \\ V_q \end{bmatrix} \quad (11)$$

The control output as reference wave is fed along with the carrier waves to generate switching pulses for the T-type MLI using LS-PWM switching method.

SIMULATION RESULTS

The effectiveness of the proposed converter along with the control scheme is verified through simulation in MATLAB/Simulink. Two cases have been considered for validating the proposed approach for load and source variations. The parameters listed in Table I correspond to the converter and parameters in Table II correspond to the PV module.

TABLE II Parameters of the module

Parameter	Value	Parameter	Value
V_{oc}	42.5 V	V_{mpp}	34.5 V
I_{sc}	5.4 A	I_{mpp}	3.5 A
P_{mpp}	150 W	Temperature	38°C

Case 1: Partial Shading condition on one of the modules:

Initially, the PV modules have been operated at 821 W/m² irradiance level and irradiance on one of the module has been varied to 621 W/m² to incorporate partial shading. The proposed integrated structure effectively realizes the MPPT of individual modules at both irradiance levels as depicted in Fig.3. The response of module 1 and module 2 is depicted in Fig.3(a) and Fig.3(b) respectively. It can be observed that both the modules initially operate with 120 W power and after partial shading on module 1, the power extracted on module 1 is 88 W and module 2 is 118W, thus reflecting the operation of each module closer to individual MPP. This confirms that the structure proposed realizes MPP of the individual module under partial shading. The output voltage of T-type interfaced inverter is depicted in Fig 4(a). It can be observed that the voltage response using the designed controller is regulated at the desired value irrespective of partial shading on the PV module as depicted in Fig.4(b). However, the current reduces as resulting from the reduced generated power as illustrated in Fig.4(c).

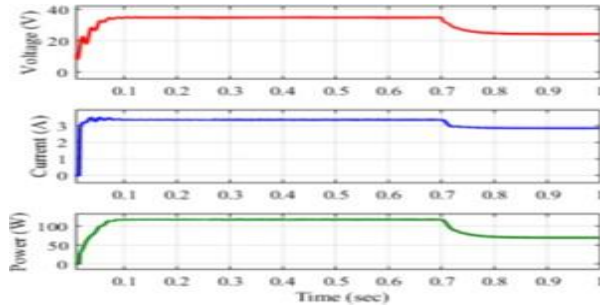

(a)

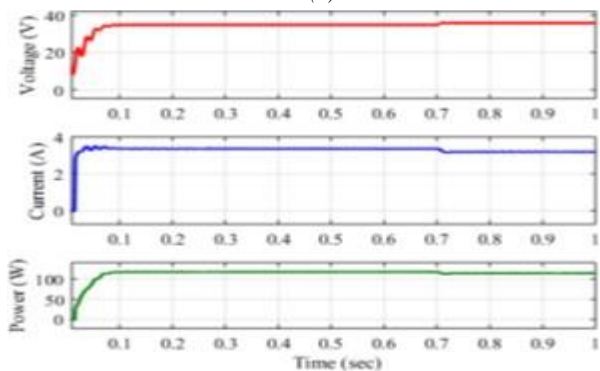

(b)

Fig.3. Voltage, current and power of (a) module 1 (b) module 2

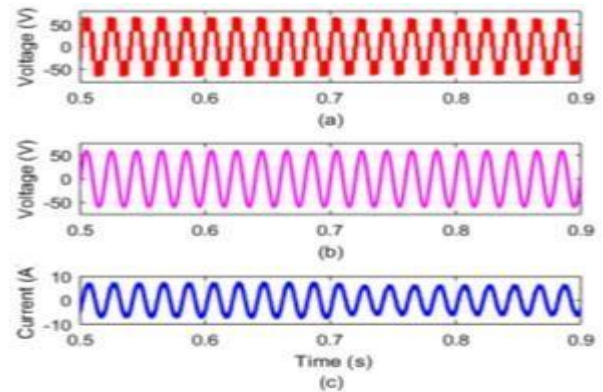
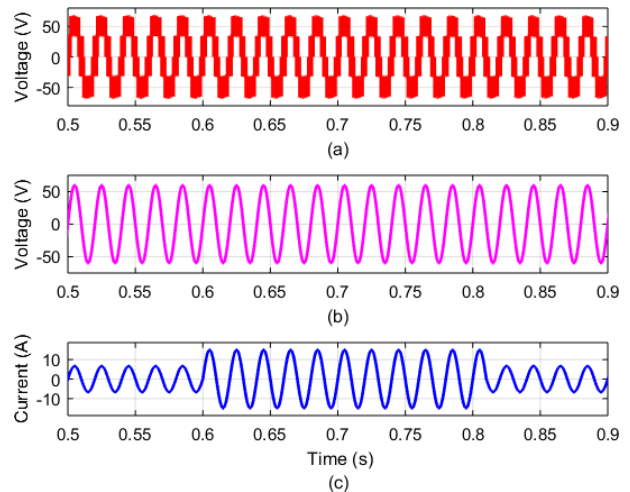

Fig.4. (a) T-type inverter output voltage (b) Grid voltage (c) Current fed to the grid

Case 2: To verify the controller performance for dynamic loading scenarios, 80W load is perturbed on existing 200W load at 0.6s and 0.8s respectively. The voltage and current response to the condition of load variation is depicted in Fig.5. The increase in load demands increases the current while maintaining a regulated five level output voltage as depicted in Fig.5(a). Despite the change in power demand, the controller regulates the load voltage to the set value as illustrated in Fig.5(b). The change in the current fed to the grid is shown in Fig.5(c).



Further to show the effectiveness of the topology in terms of minimized leakage currents for grid-connected transformerless inverters, the currents from each PV module to ground have been measured. As per German standard VDE 0126-1-1, the leakage current should not be more than a magnitude of 300mA. The measured leakage current and the common mode voltage are depicted in Fig.6 and Fig.7 respectively. It can be observed that the leakage current is far less than the limits thus reflecting the proposed topology satisfies the requirements for grid integration in terms of leakage current. In addition, the measured capacitor voltages at the input of each sub module of the inverter are depicted in Fig.8. It can be observed that the topology possess an inherent capacitor voltage balancing characteristics.

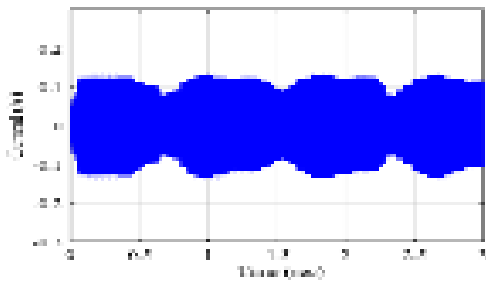

Fig. 6. Leakage current

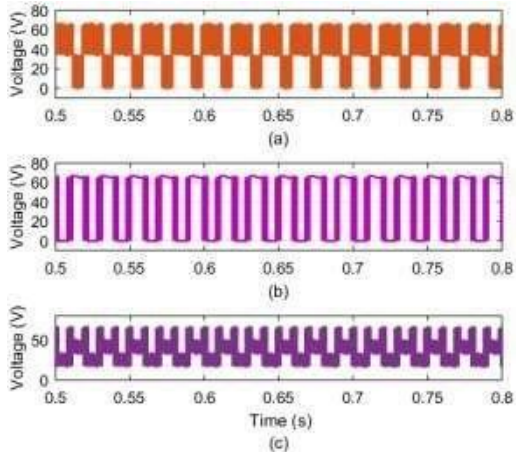

Fig.7. (a) V_{AV} (b) V_{BN} (c) Common mode

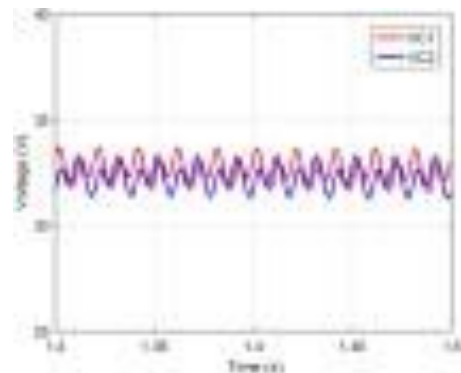

Fig.8. Capacitor voltages

CONCLUSION

A transformerless grid-connected photovoltaic multilevel inverter has been proposed in this paper. The proposed system configuration along with the step by step design of the control scheme has been discussed. The effectiveness of the controller has been verified under both load and source intermittencies. It was observed that the proposed system achieved the twin objectives of individual MPP realization and voltage regulation under load and source intermittencies. The measured leakage current and the common mode voltage validated the proposed converter for its application to the grid-connected systems. Further, the PWM technique and the controller architecture employed inherently balances the capacitor voltages.

References

- [1] On P, Energy THEG. World Energy Issues Monitor 2018 | Perspectives on the grand transition 2018. doi:10.1109/ICECE.2006.355300.
- [2] Hu H, Harb S, Member S, Kutkut N, Batarseh I, Shen ZJ. A Review of Power Decoupling Techniques for Microinverters With Three Different Decoupling Capacitor Locations in PV Systems. *IEEE Trans Power Electron* 2013;28:2711–26. doi:10.1109/TPEL.2012.2221482.
- [3] Araújo SV, Zacharias P, Mallwitz R. Highly efficient single-phase transformerless inverters for grid-connected photovoltaic systems. *IEEE Trans Ind Electron* 2010;57:3118–28. doi:10.1109/TIE.2009.2037654.
- [4] Leon JI, Vinnikov D. Grid-Connected Photovoltaic Systems: An Overview of Recent Research and Emerging PV Converter Technology. *IEEE Ind Electron Mag* 2015:47–61. doi:10.1109/MIE.2014.2376976.
- [5] Li W, Gu Y, Luo H, Cui W, He X. Topology Review and Derivation Methodology of Single-Phase Transformerless Photovoltaic Inverters for Leakage Current Suppression. *IEEE Trans Ind Electron* 2015;62:4537–51. doi:10.1109/TIE.2015.2399278.
- [6] Wu W, Ji J, Blaabjerg F. Aalborg inverter - A new type of “ buck in buck, boost in boost” grid-tied inverter. *IEEE Trans Power Electron* 2015;30:4784–93. doi:10.1109/TPEL.2014.2363566.
- [7] Modules P, Walker G, Walker GR, Sernia PC. Cascaded DC – DC Converter Connection of Cascaded DC – DC Converter Connection of Photovoltaic Modules 2002:24–9. doi:10.1109/TPEL.2004.830090.
- [8] Macalpine SM, Erickson RW, Brandemuehl MJ. Characterization of Power Optimizer Potential to Increase Energy Capture in Photovoltaic Systems Operating Under Nonuniform Conditions. *IEEE Trans Power Electron* 2013;28:2936–45. doi:10.1109/TPEL.2012.2226476
- [9] York B, Yu W, Lai JS. An integrated boost resonant converter for photovoltaic applications. *IEEE Trans Power Electron* 2013;28:1199–207. doi:10.1109/TPEL.2012.2207127.
- [10] Xiao B, Member S, Hang L, Mei J, Riley C, Member S, et al. Modular Cascaded H- Bridge Multilevel PV Inverter With Distributed MPPT for Grid-Connected Applications. *IEEE Trans Ind Appl* 2015;51:1722–31. doi:10.1109/TIA.2014.2354396.
- [11] Huang Q, Yu W, Huang AQ. Independent DC Link Voltage Control of Cascaded Multilevel PV Inverter. 2016 *IEEE Appl Power Electron Conf Expo* 2016:2727 – 34. doi:10.1109/APEC.2016.7468249.

- [12] Chavarría J, Biel D, Guinjoan F, Meza C, Negroni JJ. Energybalance control of PV cascaded multilevel grid-connected inverters under level-shifted and phase-shifted PWMs. *IEEE Trans Ind Electron* 2013;60:98–111. doi:10.1109/TIE.2012.2186108.
- [13] Johnson J, Montoya M, McCalmont S, Katzir G, Fuks F, Earle J, et al. Differentiating series and parallel photovoltaic arc-faults. *Conf Rec IEEE Photovolt Spec Conf* 2012:720–6. doi:10.1109/PVSC.2012.6317708.
- [14] Alam MK, Khan F, Johnson J, Flicker J. A Comprehensive Review of Catastrophic Faults in PV Arrays: Types, Detection, and Mitigation Techniques. *IEEE J Photovoltaics* 2015;5:982–97. doi:10.1109/JPHOTOV.2015.2397599.
- [15] Gules R, Pacheco JDP, Hey HL, Imhoff J. A maximum power point tracking system with parallel connection for PV stand-alone applications. *IEEE Trans Ind Electron* 2008;55:2674–83. doi:10.1109/TIE.2008.924033.
- [16] Liu B, Duan S, Cai T. Photovoltaic DC-Building-Module-Based BIPV System — Concept and Design Considerations. *IEEE Trans Power Electron* 2011;26:1418–29. doi:10.1109/TPEL.2010.2085087.
- [17] Rezaei MA, Lee K, Huang AQ. A High-Efficiency Flyback Micro-inverter With a New Adaptive Snubber for Photovoltaic Applications. *IEEE Trans Power Electron* 2016;31:318–27. doi:10.1109/TPEL.2015.2407405.
- [18] Staath JT, Seeman MD, Kesarwani K. Resonant switched-capacitor converters for sub-module distributed photovoltaic power management. *IEEE Trans Power Electron* 2013;28:1189–98. doi:10.1109/TPEL.2012.2206056.
- [19] Zhou Y, Liu L, Li H. A high-performance photovoltaic module-integrated converter (MIC) based on cascaded quasi-z-source inverters (qZSI) using IGBTs. *IEEE Trans Power Electron* 2013;28:2727–38. doi:10.1109/TPEL.2012.2219556.
- [20] Liu Y, Sun D, Abu-Rub H, Bi D, Peng FZ, Yan X, et al. Modeling, Impedance Design, and Efficiency Analysis of Quasi-Z Source Module in Cascaded Multilevel Photovoltaic Power System. *IEEE Trans Ind Electron* 2014;61:6108–17. doi:10.1109/tie.2014.2304913.
- [21] Huang Q, Huang A, Yu R, Liu P, Yu W. High-Efficiency and High-Density Single-Phase Dual-Mode Cascaded Buck-Boost Multilevel Transformerless PV Inverter with GaN AC Switches. *IEEE Trans Power Electron* 2018;PP:1. doi:10.1109/TPEL.2018.2878586.
- [22] Valderrama GE, Guzman GV, Pool-Mazun EI, Martinez-Rodriguez PR, Lopez-Sanchez MJ, Zuniga JMS. A single-phase asymmetrical T-type five-level transformerless PV inverter. *IEEE J Emerg Sel Top Power Electron* 2018;6:140–50. doi:10.1109/JESTPE.2017.2726989.
- [23] Aly M, Ahmed EM, Shoyama M. Modulation Method for Improving Reliability of Multilevel T-type Inverter in PV Systems. *IEEE J Emerg Sel Top Power Electron* 2019;PP:1–1. doi:10.1109/jestpe.2019.2898105.
- [24] Anthon A, Zhang Z, Andersen MAE, Holmes DG, McGrath B, Teixeira CA. The benefits of SiC MOSFETs in a T-type inverter for grid-tie applications. *IEEE Trans Power Electron* 2017;32:2808–21. doi:10.1109/TPEL.2016.2582344.
- [25] Zhang Z, Zhang J, Shao S, Zhang J. A High-Efficiency Single-Phase T-Type BCM Microinverter. *IEEE Trans Power Electron* 2018;34:984–95. doi:10.1109/TPEL.2018.2824342.
- [26] Khaled M, Ali H, Abd-El Sattar M, Elbaset AA. Implementation of a modified perturb and observe maximum power point tracking algorithm for photovoltaic system using an embedded microcontroller. *IET Renew Power Gener* 2016;10:551–60. doi:10.1049/iet-rpg.2015.0309.
- Kawamura A, Ishihara K. Real time digital feedback control of three phase PWM inverter with quick transient response suitable for uninterruptible power supply. *Conf Rec 1988 IEEE Ind Appl Soc Annu Meet* 1988:728–34. doi:10.1109/IAS.1988.25143.
- [27] Ortega R, Garcera G, Figueres E, Carranza O, Trujillo CL. Design and application of a two degrees of freedom control with a repetitive controller in a single phase inverter. *Proc - ISIE 2011 IEEE Int Symp Ind Electron* 2011:1441–6. doi:10.1109/ISIE.2011.5984372.
- [28] Tai TL, Chen JS. UPS inverter design using discrete-time sliding-mode control scheme. *IEEE Trans Ind Electron* 2002;49:67–75. doi:10.1109/41.982250.
- [29] Zhou K, Yang Yunhu. Phase Compensation Multiple Resonant Control of Single-phase PWM Inverter, 2012,

- [30] Khajehoddin SA, Karimi- Ghartemani M, Jain PK, Bakhshai A. A resonant controller with high structural robustness for fixed-point digital implementations. *IEEE Trans Power Electron* 2012;27:3352–62. doi:10.1109/TPEL.2011.2181422.
- [31] Ryan MJ, Lorenz RD. Synchronous-frame controller for a single- phase sine wave inverter. *Conf Proc - IEEE Appl Power Electron Conf Expo - APEC* 1997;2:813–9. doi:10.1109/APEC.1997.575739.
- [32] Monfared M, Golestan S, Guerrero JM. Analysis, design, and experimental verification of a synchronous reference frame voltage control for single-phase inverters. *IEEE Trans Ind Electron* 2014;61:258–69. doi:10.1109/TIE.2013.2238878.
- [33] Zhang R, Cardinal M, Szczesny P, Dame M. A Grid Simulator with control of single-phase power converters in D-Q rotating frame. *PESC Rec Annu Power Electron Spec Conf* 2002;3:1431–7. doi:10.1109/PSEC.2002.1022377.
- [34] Roshan A, Burgos R, Baisden AC, Wang F, Boroyevich D. A D-Q frame controller for a full-bridge single phase inverter used in small distributed power generation systems. *Conf Proc - IEEE Appl Power Electron Conf Expo - APEC* 2007:641–7. doi:10.1109/APEX.2007.357582.
- [35] Saitou M, Shimizu T. Generalized theory of instantaneous active and reactive powers in single-phase circuits based on Hilbert transform. *2002 IEEE 33rd Annu IEEE Power Electron Spec Conf Proc* 2002:1419–24. doi:10.1109/PSEC.2002.1022375.
- [36] Ciobotaru M, Teodorescu R, Blaabjerg F. A new single-phase PLL structure based on second order generalized integrator. *PESC Rec - IEEE Annu Power Electron Spec Conf* 2006:1–6. doi:10.1109/PESC.2006.1711988.
- [37] Rae-Young Kim, See-Young Choi, In-Young Suh. Instantaneous control of average power for grid tie inverter using single phase D- Q rotating frame with all pass filter. *30th Annu Conf IEEE Ind Electron Soc* 2004 *IECON* 2004;1:274–9. doi:10.1109/IECON.2004.1433322.
- [38] Rae-Young Kim, See-Young Choi, In-Young Suh. Instantaneous control of average power for grid tie inverter using single phase DQ rotating frame with all pass filter. *30th Annu Conf IEEE Ind Electron Soc* 2004 *IECON* 2004;1:274–9. doi:10.1109/IECON.2004.1433322

COMPARISON OF CHARGING TECHNOLOGIES FOR ELECTRIC VEHICLE BATTERY CHARGING

K.S.M. Manjula, 16JG1A0213
S.Bhargavi, 16JG1A0227
IV B.Tech, EEE

Abstract—The objective of reducing pollution levels widely promotes the usage of electric vehicles (EVs) throughout the globe. Government of India also works in this regard with the motto of having 30 percent electric vehicle mobility by the year 2030. However, unlike many other nations, India is still developing the charging stations, which is the major limitation for the usage of EVs in India. To provide an idea of different charging technologies and their performance, Most of the fast charging techniques proposed in the state of the art have a major limitation of degrading the battery performance. In this regard, this work investigates the performance of the widely employed fast charging technique when implemented to a conventional buck converter. Further, comparison of the technique with conventional charging techniques is also presented.

Index Terms—Constant current charging, constant voltage charging, buck converter

I. INTRODUCTION

The increased concern about the environment and rapid growth in the price of crude oil has resulted in increased research in the alternative to conventional automobile vehicles. The research resulted in the development of EV technology, a clean mode of transportation [1]. The key features like environment friendly, less maintenance and low energy consumption made EV emerge as a new era in the mode of transportation. Most of the EVs are powered by battery alone and hence are limited in the range. Moreover, the availability of charging stations and the time taken to charge the battery is the major limitations [2]. The battery technology in recent times is Lithium-ion technology. The advantage of the Li-ion batteries is a long life, high energy density, higher number of charge-discharge cycles and durability [3-4], compared to its counterpart, the conventional lead-acid batteries. The time taken to charge the battery is the major limitation for the development of the charging stations and limited EV usage in most of the developing countries like India. The conventional methods of charging the battery include constant voltage (CV)

charging method and constant current (CC) charging method [5]. Both methods are widely employed and have their pros and cons. The CV method charges the battery without the degradation of battery performance, however, takes a very long time to completely charge the battery. On the other hand, CC method charges the battery in a less time comparatively; however, due to high currents near the upper cut off value of the voltage, the chance of performance degradation is high and is also risky. Hence, it is a general practice to use the CV method more often and the CC method with more precautions take. However, to reduce the risk of high currents, most of EVs used CV method, in which charging time is too high approximately 7-8 hours.

In this regard, there has been increased research on charging techniques of the battery in the recent era. Based on the research, various safe and precise fast charging techniques have been developed and reported in the literature. One of the most popular and widely employed techniques is the CC-CV method [6]. The CC-CV method, even though is popular, very few works of literature reports the comparison of the performance concerning the conventional CV method. In this regard, this paper aims to investigate the performance of the two methods and highlight the advantages of the CC-CV method quantitatively. Further, the CC-CV method has been implemented using a power electronic converter to charge the battery.

The rest of the paper is as follows: Section II briefs the CC-CV method. Section III deals with the implementation of the CC-CV method for charging the battery followed by the comparison with the CV method. Finally, Section IV summarises the paper.

II. CC-CV method

As mentioned, one of the most widely adopted fast charging technique is CC-CV method. In this section, the charging method to charge Li-ion cells has been briefed. The battery initially is made to charge at a constant rate of current, generally in the range 0.5C to 1C specified by the manufacturer. In general, the battery is available as a battery pack, with cells connected in series-parallel combination. During charging, the cell equalization technique is generally preferred [6-7]. With the

assumption of balanced cells, the battery is charged through CC method till the voltage reaches $4.2N$, where, N represents the number of series-connected cells and 4.2 , the maximum voltage for a Li-ion cell. Further, the charging continues in the CV method to limit the stress on cells due to overvoltage. This helps in the improvement of the performance of the battery. Moreover, the usage of the CC-CV technique reduces the charging time drastically, up to 60-120 minutes from 7-8 hours. However, safety precautions are to be taken for limiting the temperature to avoid excessive cell heating. As a case study, the working of the CC-CV method is discussed for a 24 V battery. The maximum chargeable and minimum dischargeable voltages for 24 V battery is said 28 V and 15V respectively. In this method of charging, the battery is charged with a preset value of current generally, in the range $0.5C - 1C$. The process is continued until the battery reaches the maximum voltage. At this instant, the battery is charged by applying a constant voltage. The same has been illustrated in Fig.1. The first stage is the initial pre- charging stage; the second stage is the intermediate CC stage followed by the CV charging stage at the end.

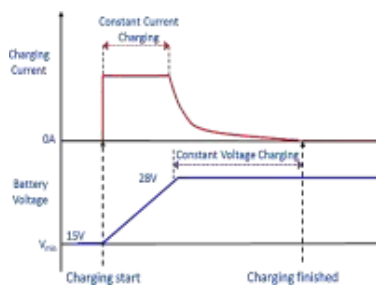

Fig 1. Stages in CC-CV charging method

In the first stage, the current is slowly increased in steps until the battery voltage slowly raises to the constant current threshold value which protects the battery from damage. In the second stage, the battery is charged with a high value of constant current. Once the battery reaches the maximum voltage, the battery is charged with the constant voltage which is the last stage for avoiding the overcharge and thereby protecting the battery. The charging time of the battery in the standard CC/CV method is given by [8]

$$\text{Charging time (hrs)} = 1.3 \times \frac{\text{Battery capacity (Ah)}}{\text{Charging current during CC}}$$

In most of the cases, the mode transition is done based on the state of charge (SoC) of the battery [9]. Initially, the battery is charged with the constant current up to a predefined SoC level (mostly 80%). When the battery reaches 80% SoC level the transition in the charging mode occurs from constant current mode to constant voltage mode. The flow chart in Fig.2 depicts the CC- CV technique. The SoC of the battery can be estimated in terms of open-circuit voltage.

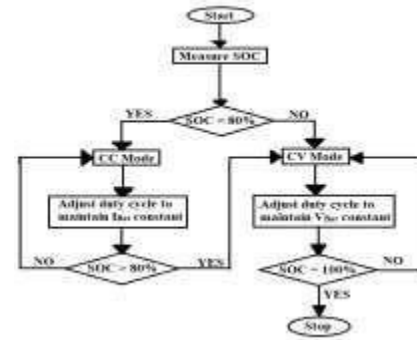

Fig 2: Flow Chart of CC-CV method

III. Implementation of the CC-CV method

In this work, the CC-CV method is implemented using a buck converter for charging the Li-ion battery [10]. The block diagram of the implemented system is depicted in Fig.3.

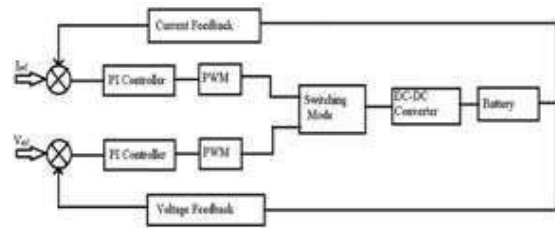

Fig 3. Control Loop Block Diagram for the CC-CV Charging Scheme

The output voltage and current are sensed from which the SoC can be estimated. In CC mode, the PI controller in the current loop adjusts the duty cycle of the buck converter to maintain the constant current throughout this mode. The controller adjusts the duty cycle to maintain the constant current irrespective of the change in input voltage. Similarly, in CV mode the PI controller in the voltage loop adjusts the duty cycle of the converter to maintain a constant voltage. The transition of the mode of charging occurs depending on the SoC or open-circuit voltage of the battery. When SOC becomes 100% or the open-circuit voltage reaches the maximum value, the battery is considered as completely charged.

CONCLUSION

This method has been implemented for a 24V, 13Ah, Li-ion battery using a buck converter. Further, the superiority in charging time compared to CV method has been investigated. It has been observed that the CC-CV charging method charges the battery five times faster than the CV method. Moreover, the results also show a proper dynamic behaviour of the battery voltage, current and the SOC confirming that the chances of performance degradation are quite low. The CC-CV method due to reduced charging time without performance degradation of the battery is best suited for the establishment of the fast-charging stations to promote EVs in developing countries.

ENERGY AUDIT - A CASE STUDY OF AN INSTITUTIONAL BUILDING

V.Harika,17JG1A0234
B.Pallavi ,17JG1A0204
III B.Tech. EEE

I. INTRODUCTION

Abstract: Energy is the most important factor that is accountable for economic development of a country. Energy should be managed in such a way that we utilize it in a most efficient manner. The exact information on the energy wastages is required to minimize the wastage. An Energy Audit is a survey, an inspection and an investigation of energy flow for energy conservation or it is a process to decrease the amount of energy input into the system without compromising its utilization. An energy audit is a testing and analysis of how the enterprises and other organizations use energy.

Educational Institutions are often overlooked as a contributor to energy intensive operations in India within the commercial buildings sector. An energy cost is one of the manageable costs within an institute's budget and can be managed effectively. Resultant cost and energy savings will go a long way in reducing energy use within the sector and provides a venue for reinvestment within the educational institute itself.

An energy study review of various international and national educational institutions indicates that 5-20% of energy can be saved. This paper presents an audit report that is aimed at "Managing Energy use in institution- Gayatri Vidya Parishad College of Engineering for Women". It is a concerted attempt in achieving improved energy performances. This study aims to highlight several opportunities to create and implement an energy management plan within institution. The audit was conducted and suitable strategies of adjusting and optimizing energy were suggested so as to reduce energy requirements

Keywords— Energy Audit, Institutional Building, Pay Back Period, Different Loads

A nation is fully advanced in proportion to the spread of education among the common people and development of their intelligence. In India the entire field of education and other fields of intelligent activities had been monopolized by a handful of men before independence. But today we are marching towards the desirable status of a developed nation with fast strides. But the development should be a sustained one. For achieving such an interminable development energy management is essential [1].

The present electricity consumption in the commercial buildings sector in India is about 8-10% of the total electricity. The electricity demand in commercial buildings is growing annually by 11-12% due to demands for providing international level comforts and facilities. This presents a challenge to ensure that energy growth in commercial building does not become unmanageable, but at the same time, also presents an opportunity to influence and address energy management issues in various commercial buildings and facilities [2-4].

II. AUDIT PHASE

The energy audit is a wide spectrum of energy study which ranges from identifying major energy problem areas to implications of alternative energy efficient measures. It involves analyzing the actual consumption of electrical energy and measures of energy conservation. Energy Audit helps to understand more about the ways energy and fuel are used in any industry and help in identifying the areas where waste can occur and where scope for improvement exists.

Initially a walk through" audit was conducted in every room and investigated. The connected load and its wattage were noted. During such visit macro information like number of hours of actual usage of fluorescent light, fan, power points etc. was collected. The main objective was to explore the major energy problem. It was found that there was a scope for conduct of a General audit.

The general audit was conducted by measurement

of actual energy consumption, duration .The size of the rooms and the electrical fittings in it like light, fan and air- conditioners, electric motors were noted. The measurement was conducted both inside the rooms and in common places like bathrooms, toilets etc.

It was observed that if the energy efficient measures are suggested in three categories Viz., Lighting, Ventilation & heating / cooling, it will fetch a fruitful result. Accordingly, in depth analysis of these three categories were carried out. The outcome / suggestions are listed below:

Recommended Energy Saving Measures

Audit Parameter

(i): Fluorescent Lamp

Replacing the 40 watt Lamp with 20 Watt lamp :-

a) Wattage of Existing Lamp = 40W
 Duration of use / year / lamp days = 12Hrs. X 365 = 4380hours
 Total Number of lamps = 107
 Total energy consumption (40 X 4380X 107) =18746.4KW
 Wattage of CFL (proposed) = 20 W
 The difference in energy consumption= 20 W
 Total energy consumption with replacement = 20X4380X107=9373.2KW
 The difference in energy consumption = 18746.4- 9373.2=9373.2KW
 Saving, i.e difference in energy bill: Cost / Unit @ Rs.5/- (1 unit = 1 KWh)
Saving = 9373.2* 5= Rs.46866/-

b) Cost of 40Wlamp @ depreciation factor of 50% D =208*107= Rs 22256.00
 Cost of installation of 20 W lamp=400*107= Rs.42800/-
 Additional expense= 42800-22256=Rs.20544/-
 Payback period =20544/46866=0.44 years

Audit Observation : Life of CFL is approx 3 to 4 years. The additional cost incurred towards the replacement will be paid back in 4 to 5 months time period. Hence, it was suggested that 40 watt fluorescent lamp may be replaced with 20 Watt CFL. The Comparison of existing energy consumption with recommended consumption in case of fluorescent lamp is shown in Fig.1.

Table 1 Comparison before and after recommended energy for lamp

Details of lamps	Fluorescent bulb	CFL
No of lamps	107	107
Watt per lamp	40	20
Cost per lamp	Rs.450	Rs.400
KWh energy consumed by the Lamp	4280 KWh	2140 KWh
Cost of energy consumed at Rs 8/KWh	Rs. 34320	Rs 17120
KWh energy consumed per Year	18746.4 KWh	9373.2 KWh
Cost of energy consumed per Year	Rs.149971.2 per Year	Rs.74985.6 per year

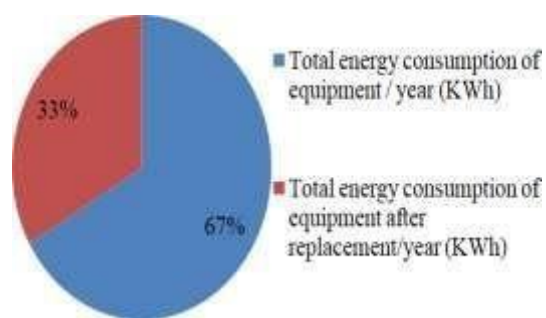

Fig.1. Comparison of energy savings of a Lamp

From Fig.1. it is clear that by replacing the normal lamps with CFLs there is an energy savings of about 33% with a very less payback period of 4-5 months.

In similar way the energy saved in case of replacing the fans with energy efficient fans has been calculated and presented in Table 2 and fig.2 It can be observed that there is savings of about 15% with the replacement.

Table 2 Comparison table before and after recommended energy for fan

Details of Fan	Normal Fan	Energy Efficient Fan
No of fans	108	108
Watt per fan	70	50
Cost per fan	Rs.1200	Rs.1900
KWh energy consumed by the fan	7560 kWh	205.2 KWh
Cost of energy consumed at Rs 8/KWh	Rs. 60480	Rs 1641.6
KWh energy consumed per year	33112.8 kWh	23652.0 KWh
Cost of energy consumed per year	Rs.264902.4 per year	Rs.189216 per year

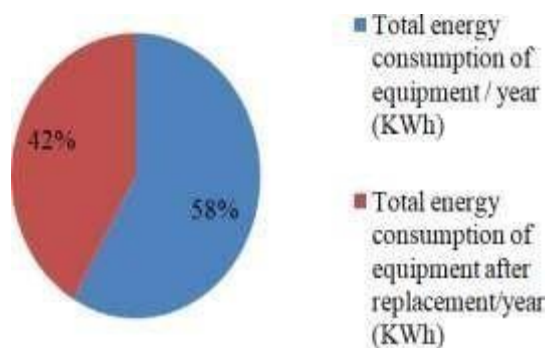

Fig.2. Comparison of energy savings of a Fan

On the same lines, the energy savings by replacing the air conditioners (ACs) with energy efficient ACs has been calculated. The details have been presented in Table 3 and the same has been depicted in Fig.3. It can be observed that there is a very high savings of about 34% with the change.

Table 3 Comparison table before and after recommended energy for AC

Details of Air Conditioner	Normal Air Conditioner	Energy Efficient Air Conditioner
No of Air conditioner	7	7
Watt per Air conditioner	7034	3504
Cost per Air conditioner	Rs.25,000	Rs.40,000
KWh energy consumed by the Air Conditioners	49238 KWh	24528 KWh
Cost of energy consumed at Rs 8/KWh	Rs. 3,93,904.00	Rs1,96,224.00
KWh energy consumed per Year	1,25,803.09	62,669.04 kWh
Cost of energy consumed per Year	Rs10,06,424.72/-	Rs.50,13,523.20/-

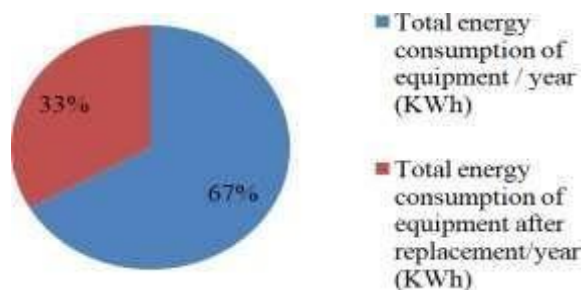

Fig.3. Comparison of energy savings of an Air Conditioner

Similarly, the energy that can be saved by replacing the existing motors in the institute with energy efficient motors [5] that do the same work has been calculated. The detailed energy saving and the cost is illustrated in Table 4. The same has been depicted in Fig. 4. It can be observed that the energy consumption per year has been reduced drastically about 20%.

Table 4 Comparison table before and after recommended energy for motor

Details of Motor	Normal Motor	Energy Efficient Motor
No of motors	15	15
Watt per motor	3728.5	2500
Cost per motor	Rs.8000	Rs.10000
KWh energy consumed by the motor	55927.5KWh	37500KWh
Cost of energy consumed at Rs 8/KWh	Rs. 447420	Rs 300000
KWhenergy consumedper year	122481.225 kWh	82125 KWh
Cost of energy consumed per year	Rs.979849.8 per year	Rs.657000 per year

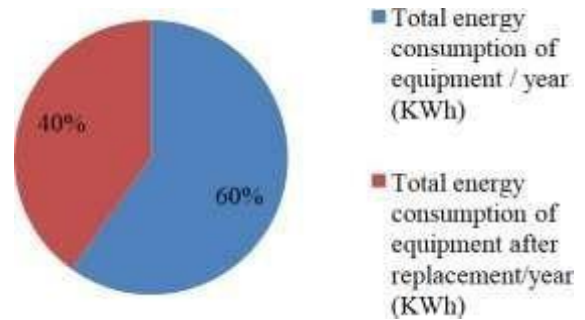

Fig.4. Comparison of energy savings of a Motor

References

1. Hand Book of Energy Audit by Sonal Desai- Tata McGraw hill
2. R. Hari Baskar, Hitu Mittal, Mahesh S Narkhede, Dr. S.Chatterji, "Energy Audit-A Case Study", International Journal of Emerging Technology and Advanced Engineering, pp 73-78, 2014
3. Muhammad Usman Khalid, Mariam Gul, Mohammad Mohsin Aman. Ahsan Hashmi—Energy Conservation through Lighting Auditl, Proceedings of International Conference on Power and Energy (PECon),Kota Kinabalu Sabah, Malasia, pp840-845, 2-5 December 2012
4. Bureau of Energy Efficiency, Ministry of Power, Government of India, —Hand Book on Energy Efficiency
Energy efficient electric motors by John .C. Andreas, Marcel Dekker Inc Ltd—2nd edition, 1995

GRID INTEGRATION CHALLENGES FOR HYBRID POWER GENERATION

Y.Kala Bharathi, 16JG1A0239

Ch.Sruthi Varma ,16JG1A0204

IV B.Tech., EEE

I. INTRODUCTION

The energy is the very important parameter for survival or today's growth we can transfer the energy from one form to other. The mainly wind and solar energies are the most available among other renewable energy sources in all over the world. In the present years, because of the rapid advances of power electronic systems the production of electricity from wind and photovoltaic energy sources have increased significantly. The deregulation of electric power utilities, environmental concerns, market uncertainty and growing concern about availability and quality of electrical power has led to development of distributed generation system. Recently, much work has been focused on interfacing DG with the grid, its operation and control. A flexible DG can be used to improve the power factor and voltage fluctuations of the utility. A key problem is the integration of renewable energies into the existing grid.

A Hybrid Power System (HPS) utilizes two or more energy sources, power converters and/or storage devices. The main purpose of HPS is to combine multiple energy sources and/or storage devices which are complement of each other. Thus, higher efficiency can be achieved by taking the advantage of each individual energy source and/or device while overcoming their limitations. Recent advancement in FC technology for grid enhancement has exposed its significant potential and considers an indispensable energy source for the future power system. FC is a static energy source that generates electricity from hydrogen through electrolysis. The superior reliability, with practically zero noise level or no moving parts is an extra advantage of FC system as compared to the diesel generator. Main characteristics of FC include modularity, near zero emissions, fuel flexibility, premium power quality, high efficiency and practically low noise levels. Other advantages of FC are the distributed and centralized configurations, diversity of fuels, cogeneration options and reusability of exhaust gases for heating of buildings. The combined use of FC with an Electrolyser (ELZ), hydrogen storage tanks and

compressor unit provide a new energy storage concept. Since, hybridization of FC stacks with PV panels will, therefore, form an alternate energy conversion system where the FC acts as back up during low PV outputs to satisfy sustained load demands. There are several types of FCs which are classified on the basis of their operating temperature ranges and type of electrolyte.

II. LITERATURE REVIEW

In the research work, design and control strategy of an autonomous photovoltaic fuel-cell energy system has been developed and simulations have been performed in order to supply electricity to a DC-load without being connected to the electric grid. The various authors proposed the modelling and control of photovoltaic/wind/fuel cells hybrid generating system. Among these studies, the first part was focused on each subsystem and different parameters are identified for each subsystem. The second part proposes the design and installation of various equipment which includes voltage and current sensors, and the data acquisition is made possible by using National Instruments which allowed to obtain real time data environment. The energy system having a photo voltaic (PV) panel, wind turbine and fuel cell for continuous power flow management. Fuel cells (storage & generating) are added to ensure uninterrupted power supply due to the discontinuous nature of solar and wind resources.

There are some drawbacks in all the above mentioned studies. For example, some authors include short energy

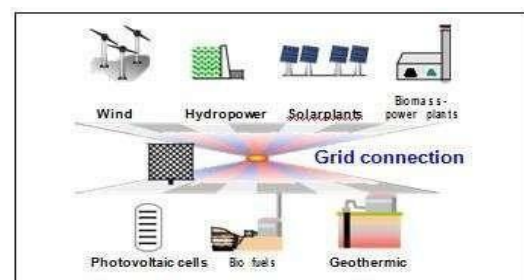

system in their studies, while others concentrate on long Figure. 1. Grid Connection

term storage medium. Some authors describe power control of PV system while others attempt to address the energy management without providing power sharing among different energy sources and/or storage system. In addition to this, most of the authors supported their studies on the basis of virtual generated solar irradiance, temperature and weather patterns.

III. RENEWABLE ENERGY SOURCES

Solar Energy -The solar energy is an unlimited source of energy which is originated from the sun. When the light and heat from the sun are used directly without changing the form, then the technology refers as a direct or passive technology of solar energy and when it used by converting the form of energy, that is called indirect or active technology of solar energy. The photovoltaic technology is the renowned indirect way and the solar thermal system is the direct way to harvest the abundant energy. There are different options for producing electricity from renewable energy sources. Consequently, there are several ways of connecting the gained electricity with the existing grid.

Wind Energy -Wind energy is the energy which is extracted from wind. For extraction we use wind mill. It is renewable energy sources. The wind energy needs less cost for generation of electricity. Maintenance cost is also less for wind energy system. Wind energy is present almost 24 hours of the day. It has less emission. Initial cost is also less of the system.

Preferred sources are wind, hydro, solar, biomass, photovoltaic cells, bio fuels and geothermic as shown in Fig. 1. The electricity is induced by asynchronous or synchronous generators except for photovoltaic cells. This operation creates co-current flows and gets through an inverted rectifier into the power grid.

IV. GRID INTERFACE TOPOLOGY

The proposed system consist of three sources: PV, WECS and FC as shown in fig 1. The output from PV will vary depending on the two factors like solar irradiance and temperature. Maximum power from PV is tracked by using MPPT algorithm and is connected to a boost converter and then to a DC bus. The wind turbine in WECS is connected to a permanent magnet synchronous generator (PMSG). The electrical output from generator is given to a three phase full wave bridge rectifier. The dc output from rectifier is boost and then is given to a dc bus.

MPPT is also used in WECS to track maximum power from wind turbine. The FC used here is a

hydrogen fuel cell, the output is taken to a boost converter and then given to the dc bus. The dc loads can be connected to this dc bus else this dc is converter to ac by using a three phase inverter and is given to ac loads or grid.

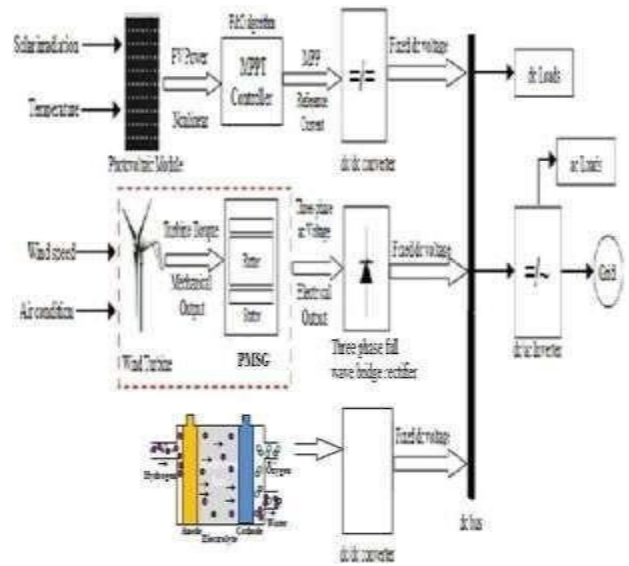

Figure 2. Block Diagram of Proposed System

Table.1. Main challenges and possible solutions for grid- connected system

No.	Challenges	Solutions
1	Voltage fluctuation due to variations in wind speed and irregular solar radiation	Series and shunt active power filters. Power compensators such as fixed/switched capacitor or static compensator. Less sensitive customer equipment to power disturbance/voltage distortion and utilities line conditioning systems
2	Frequency fluctuation for sudden changes in active power by loads	PWM inverter controller for regulating three-phase local AC bus voltage and frequency in a microgrid.
3	Harmonics by power electronics devices and non-linear appliances.	PWM switching converter and appropriate filters.

4	Intermittent energy's impacts on network security	<p>Accurate statistical forecasting and scheduling systems. Regression analysis approaches and algorithms for forecasting weather pattern, solar radiation and wind speed.</p> <p>Increase or decrease dispatchable generation by system operator to deal with any deficit/surplus in renewable power generation.</p> <p>Advanced fast response control facilities such as Automatic Generation Control and Flexible AC Transmission System.</p>
5	Synchronization	<p>The most popular grid synchronization technique is based on phase-locked loop. Other techniques for synchronization include detecting the zero crossing of the grid voltages or using combinations of filters coupled with a non-linear transformation.</p>

V . CONCLUSION

The main challenge for grid- connected system as well as the stand-alone system is the intermittent nature of solar PV and wind sources. In this proposed system, a novel PV, WT and FC hybrid power system can be designed and modelled for smart grid applications. The performance of this system is based on DG system connected to grid. In grid-connected mode, the voltage and frequency are controlled by the grid. Thus, the DG units are controlled to provide specified amount of real power depending upon the rating of the units. A control strategy can be developed using decouple method to control the active and reactive powers independently from the solid oxide fuel cell. This study provides a review of challenges and opportunities on integrating solar PV and wind energy sources for electricity generation.

IMPLEMENTATION OF HYSTERESIS VOLTAGE CONTROL FOR DIFFERENT INVERTER TOPOLOGIES

L.Chinnari, 17JG5A0210

T.Mounika, 16JG1A0233

IV B.Tech.,GVPCEW

I INTRODUCTION

The DC to AC power electronic converter termed as the inverter is in wide use in various industrial applications. The major applications include UPS, home inverters and even more widely in renewable energy integration [1, 2]. Renewable energy systems are the major harness for electrical power generation in the present scenario due to their reliability and cost competitiveness with the conventional thermal generation systems.

In most of the renewable energy systems, the DC-DC converter is adopted for realizing maximum power from the source. The DC power extracted is converted to AC for commercial applications. However, maintaining the regulated voltage at the load terminals for load intermittenencies is essential. For this purpose, the gate signals generated are varied using the different control strategies. Among them, most widely used control strategies are linear PI control, predictive dead-beat control and hysteresis control [3]. The linear PI control requires tuning of control parameters for obtaining the optimal gain values (K_p and K_i) for the desired transient and steady-state response. These parameters can be determined using several methods like Zeigler-Nichols method and optimization-based methods. However, these methods involve high computational efforts for obtaining the optimal values. The dead beat controller even though not widely adopted is as famous as PI controller. However, it does not ensure a zero steady-state error. Whereas, the hysteresis control technique ensures optimal tracking of the reference trajectory. Moreover, this technique requires no prior information of load parameters and has a quick response current loop. Further, the hysteresis control is more competent with respect to switching loss, fault tolerance, and total harmonic distortion.

Hysteresis current control (HCC) has proven to be the most conventional and widely adopted hysteresis control technique. This technique ensures efficient tracking of the load current resulting in a sinusoidal current to the load connected at the inverter terminals [4] - [13]. Even though the current is well regulated and

tracked, voltage regulation is equally important. However, HCC fails to regulate voltage during a sudden change in the loads. In this regard, hysteresis voltage control (HVC) has been introduced in [14]. The HVC provides a solution to issues related to voltage sags/swells in the electrical network [14], [15]. The HVC can be termed as a substitute to conventional pulse with modulation (PWM) methods. Despite the advantages of HVC, only a few works of literature adopted the HVC. With the motivation to avoid complex computations and optimizations involved in PI controller, this paper presents the implementation of HVC for different inverter topologies. Similar to HCC, HVC is also based on the hysteresis band controller which forces the output of the inverter to traces the reference signal within a constant hysteresis band. In addition to the advantages like low cost and easy implementation, the HVC provides fast transient response without additional loop compensation.

The paper is organized as follows: Section II briefs the HVC followed by its implementation for inverter topologies in section III. Section IV discusses the results followed by the conclusion in Section V.

II HYSTERESIS VOLTAGECONTROL

Hysteresis voltage control has key advantages comparatively in terms of its implementation, stability and carrier signal requirement. Based on the error signal and the hysteresis bandwidth, HVC generates the switching pulses for voltage regulation. The deviation of the actual signal from the reference voltage is termed to be the error signal. Thus generated error signal is given as the input signal to the hysteresis band of HVC. The switching occurs with the deviation of the error signal from the reference beyond the hysteresis band limit. The hysteresis band has two limits one above the reference value, termed as the upper limit and other below the reference termed as the lower limit. The ON/OFF pulses are generated when the error signal exceeds the lower and when the error signal exceeds the upper limit then OFF/ON signal is generated. This continuously generates the signals to the switches hereby generating the ac output voltage. The HVC approach is depicted in Fig.1

As mentioned above, because of its simplicity in implementation, the inverters with hysteresis control are widely employed in various low and medium voltage applications in which line current tracks its reference within a predefined error margin. The harmonic content present in the inverters highly depends on the switching pattern employed. Unlike PWM techniques, the switching pattern in hysteresis control is not pre-determined, however, is produced through line current feedback. Hence, it can be stated that the hysteresis control is an alternative to conventional PWM techniques employing PI controllers for reference wave generation.

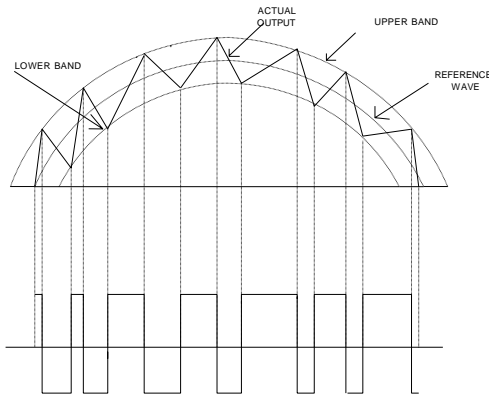

Fig. 1. The model waveform of Hysteresis control

III IMPLEMENTATION OF HVC FOR INVERTER TOPOLOGIES

The HVC strategy has been implemented for basic half-bridge, full-bridge and T-type multilevel inverter topologies.

a) Half-bridge inverter (HBI)

A single-phase HBI circuit is depicted in Fig.2. The circuit consists of constant and balanced dc sources ($V_{dc1}=V_{dc2}=V_{dc}$). The switching pulses of the switches S1 and S2 control the voltage of the inverter.

In HVC, the switching pulses are generated based on the deviation of the load voltage V_L from the given reference voltage V_{ref} . Further, the tolerance band (V_b), determines the frequency of operation of the switches. If the measured output voltage exceeds the upper limit of hysteresis band ($V_{ref} + V_b$) the switch S1 is turned off, and switch S2 is turned on resulting in the decay of the voltage starts. On the other hand, if the actual voltage exceeds the lower limit of hysteresis band ($V_{ref} - V_b$), the switch S1 is turned on, the switch S2 is off resulting in an increase of voltage. This ensures that the actual output is always in the limits of the hysteresis band. The hysteresis band limit, in this case, has been fixed to $\pm 5\%$.

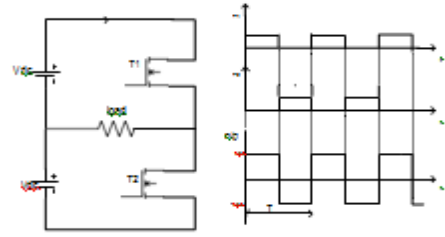

Fig. 2. Schematic of HBI

b) Full bridge inverter (FBI)

The conventional FBI circuit is depicted in Fig.3. The dc voltage is supplied by a constant dc source (V_{dc}). The switching pulses to the switches S1, S2, S3 and S4 control the voltage of the inverter.

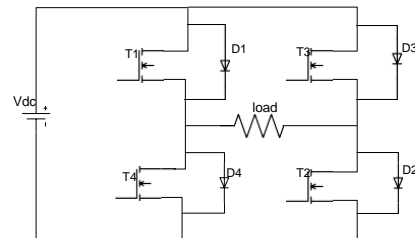

Fig. 3. Schematic of Single phase FBI

As discussed before, similar to a HBI, the switching pulses are generated based on the deviation of the load voltage V_L from the given reference voltage, V_{ref} . In this case, when measured output voltage crosses the limit of hysteresis band $(V_{ref} + V_b) / (V_{ref} - V_b)$ the switches S1, S2 are off/on, the switches S3, S4 are on/off.

c) T-type Multilevel Inverter (T-MLI)

A conventional T-MLI depicted in Fig.4 is considered. The switching signals are generated from the error signal resulted by comparing the reference voltage signal and actual voltage signal. The levels are generated by considering the limits and operating the switches within the limits. The switching table for different levels is illustrated in Table I. In order to generate these levels, the switches are turned on and off based on the limits of the error signal.

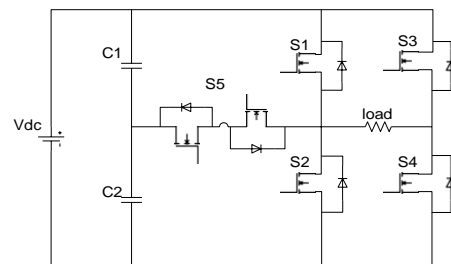

Fig. 4. Schematic of T-MLI

Table I Switching states for T-MLI

S1	S2	S3	S4	S5	V _{out}
0	0	1	0	1	-V _{dc} /2
0	1	1	0	0	-V _{dc}
0	1	0	1	0	0
1	0	1	0	0	0
1	0	0	1	0	+V _{dc}
0	0	0	1	1	+V _{dc} /2

IV. SIMULATION RESULTS

The HVC has been implemented in the MATLAB/Simulink environment for validation of HVC for HBI, FBI and T-MLI circuits. The parameters considered are V_{dc}=100V, L=5mH, C=1070μF, R=10Ω. The waveforms of output voltage with reference voltage and hysteresis band, current and pulses are as follows;

a) HBI: The HBI output voltage along with the reference voltage and the hysteresis band provided is depicted in Fig.5. The final output voltage is observed for the different loads as shown in fig.6. The load is added for the time intervals of 0.2-0.5 sec. and 0.7-0.8 sec. from the fig.6 we observe that when load changing conditions the current will increase and the voltage remains unchanged.

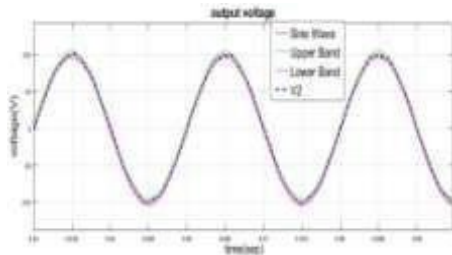
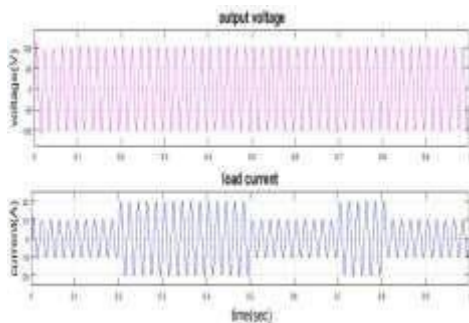

Fig.5 Waveform of the HBI output voltage



Waveform of the output voltage and load current

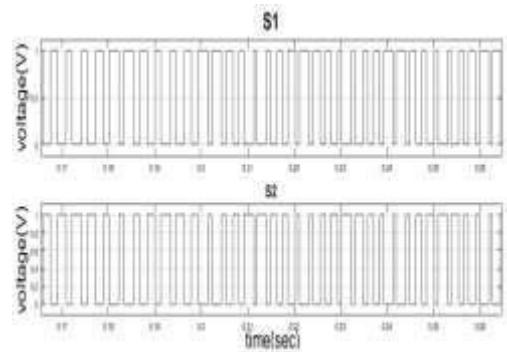

Fig.7 Waveform of the pulses to the switches

The pulses are produced based on hysteresis control then the output voltage controlled with the band.

The total harmonic distortion (THD) has been observed as shown in Fig.8. From this, it is observed that THD is 4.92%. The harmonic content is reduced by using hysteresis voltage control. The dominant harmonic is 7th harmonic at 350Hz.

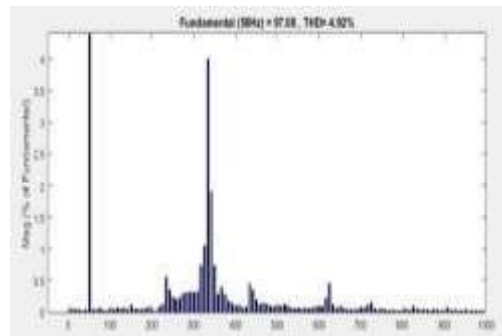

Fig.8 THD analysis of HBI

b) FBI : The output voltage with a reference voltage and the hysteresis band provided for R=15Ω is depicted in Fig.9. The load voltage of the full-bridge inverter is observed for the load changing conditions as shown in fig.10.

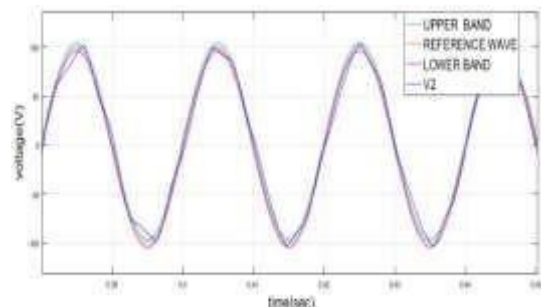

Fig.9 Waveform of the FBI output voltage with band limits

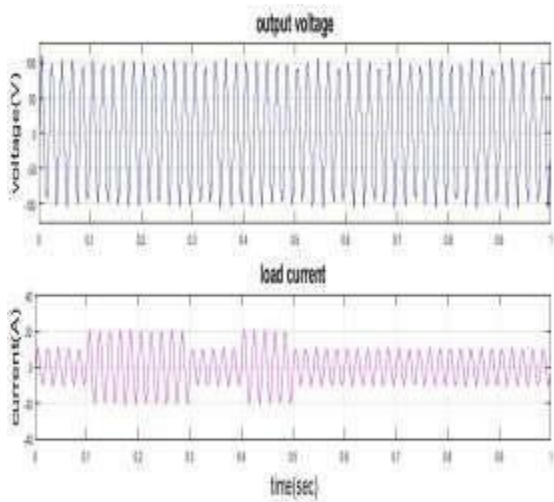

Fig.10 Waveform of the output voltage and current

Loads are added at the time intervals of 0.1-0.3, 0.4-0.5, and 0.65- 0.8 sec. the current increased at that interval and the voltage remains unchanged validating the effectiveness of the controller for load change.

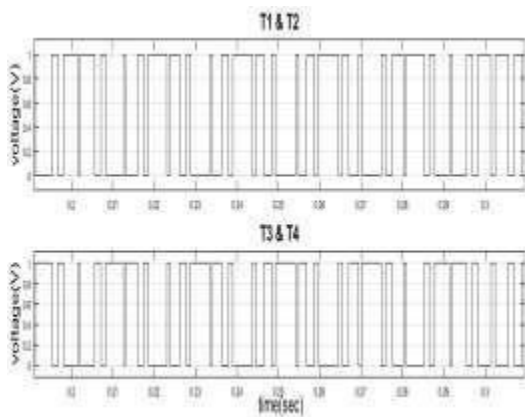

Fig.11. Waveform of the Switching pulses to the switches

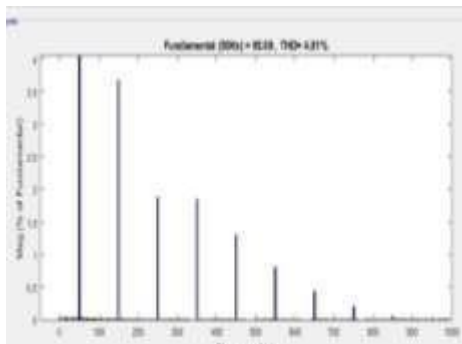

Fig.12 FFT analysis of FBI

The switching pulses generated by the HVC are depicted in Fig.11. The THD is depicted in Fig.12. It is observed that THD is 4.81%. The dominating harmonic is the 3rd component at 150Hz.

C) T-MLI: The T-MLI voltage with and without filter, the load current is observed from the Fig.12. The load is added at the time intervals of 0.4-0.5 and 0.7-0.85. At the time intervals when load added the current increases but the load voltage remains the same.

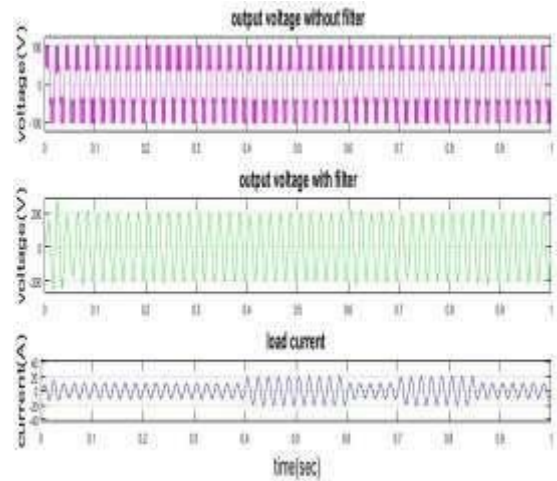

Fig.12 Waveform of the output voltage and current of T-MLI

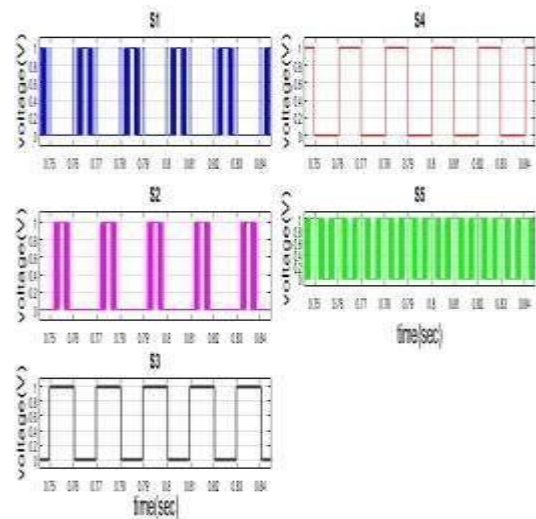

Fig.13 Waveform of the pulses to the switches

From Fig.14 it is observed that the THD is 1.28%. The dominating harmonic is the 3rd component at 150Hz.

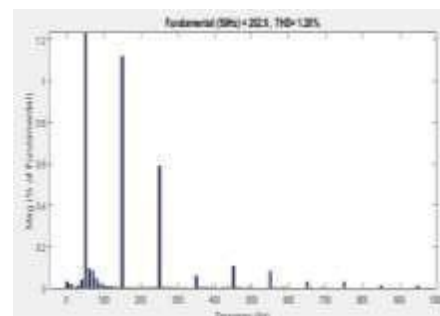

Fig.14. FFT Analysis of T-MLI

CONCLUSION

This paper investigated the possibility of implementing hysteresis voltage control (HVC) for different inverter topologies. The observations of the investigation validated the possibility of implementing HVC for regulating the load voltage of half-bridge, full-bridge and T-type inverters. Further, it is also observed that the output voltage is well regulated in a very short duration for load intermittencies. Moreover, the HVC also possess all the advantages of hysteresis control such as ease of implementation, fast and stable response, and no computational efforts to obtain gain values as in the PI controller. The HVC is implemented in MATLAB/Simulink environment and the results validate the performances of the HVC by tracking the reference under load intermittencies.

References

- [1].K. Zeb, W. Uddin, Muhammad A. Khan, Z. Ali, M. U. Ali, N. Christofides, et al., "A comprehensive review on inverter topologies and control strategies for grid connected photovoltaic system," *Renewable and Sustainable Energy Reviews*, vol. 94, pp. 1120-1141, 2018/10/01/ 2018.
- [2] K. Matsui, Y. Kawata, and F. Ueda, "Application of parallel connected NPC-PWM inverters with multilevel modulation for AC motor drive," *IEEE Transactions on Power Electronics*, vol. 15, no. 5, pp. 901-907, 2000.
- [3].P.A.Dahona, I.Krisbiantoro "A Hysteresis Current Controller For Single Phase Full Bridge Inverters", *IEEE* 2001,pp 414-419 [3] P.A.Dahona, "New Hysteresis Current Controller For Single Phase Full Bridge Inverters", *IET Power Electron*, 2009,Vol.2, Iss. 5,pp 585-594.

DEPARTMENT ACTIVITIES

S. No.	Activity type	Name of the Topic/subject	Date	Resource Person/Judge	Student Participation
1	Webinar	Electrical Automation and Technology	13 th July 2020	Mr. Deepak Sundaram CEMS	II/III/IV EEE
2	Online FDP	Applications of Optimization Techniques to Electrical Engineering	22-26 June, 2020	Dr Sankar Peddapati, Dr Siddarth Panda, Dr I Satish Kumar Dr Subhojit Ghosh and Dr T V Dixit	Faculty
3	Webinar	Energy Audit and Management: Importance and Career Perspective	29 th August, 2020	Mr. R.V. Ramana Rao SE, APEPDCL (Retd.)	Faculty and Students
4	Webinar	A webinar on Power Quality issues and Challenges in Microgrid	28 th May 2020	Dr Sinivas Bhaskar Karanki, Assistant Professor, School of Electrical Sciences, IIT Bhubhaneswar.	Nationwide faculty
5	Workshop	A Two Day Workshop On Solar MPPT Techniques	11 th March 2020 & 12 th March 2020	Dr T V Dixit, Dr P Devendra, Mr. A. Hema Chander	II, III & IV EEE
6	Workshop	Introduction to Optimization Techniques	26 th Feb 2020	Mr. Madhu Kiran, GVPCEW	II, III EEE

Department Activities Organised for the Year 2020



Workshop on “Introduction to Optimization Techniques” by Mr. Madhu Kiran, held on 26-02-2020



Workshop On “Solar MPPT Techniques” by Dr. T V Dixit on 11th-12th March, 2020.

STUDENT ACTIVITIES

TOPPERS OF THE YEAR:

YEAR	ROLL NO	NAME OF THE STUDENT	AVERAGE CGPA	POSITION
IV	16JG1A0213	K. Sai Mani Manjula	8.57	First Class with Distinction
III	17JG1A0231	U.Ramya	8.42	First Class with Distinction
II	18JG1A0224	Preethi Chouhan	8.93	First Class with Distinction

CERTIFICATION COURSES BY STUDENTS:

SL.NO	STUDENT NAME	COURSE NAME	PERIOD
1	B.Prasanna Jyothi	Industrial Automation With PLC	27/07/2020
2	S.Sangeetha	Basic Python Programming	06/07/2020
3	Y.Sowmya	Industrial Automation With PLC	22/06/2020
4	M.Suneetha	Industrial Automation With PLC	22/06/2020
5	S.Uma Maheswari	Basic Python Programming	22/06/2020
6	Ch.Yamini	Industrial Automation With PLC	22/06/2020
7	V.Hema Sri	Internet Of Things	01/06/2020



INTERNSHIP DONE BY THE STUDENTS:

SL.NO	STUDENT NAME	INTERNSHIP ATTENDED AT	PERIOD
1	17JG1A0202	Hyderabad institute of Electrical Engineers	01/05/2020 to 16/05/2020
2	17JG1A0214	BITS PILANI	28/07/2020 to 28/08/2020
3	17JG1A0221	Hyderabad institute of Electrical Engineers	01/05/2020 to 16/05/2020
4	17JG1A0231	Hyderabad institute of Electrical Engineers	01/05/2020 to 16/05/2020
5	17JG1A0233	Hyderabad institute of Electrical Engineers	01/05/2020 to 16/05/2020
6	17JG1A0234	APSSDC	01/06/2020 to 13/06/2020
7	17JG1A0234	APSSDC	22/06/2020 to 04/07/2020
8	17JG1A0234	APSSDC	13/07/2020 to 01/08/2020
9	18JG5A0201	APSSDC	27/07/2020 to 08/08/2020
10	18JG5A0202	APSSDC	22/06/2020 to 04/07/2020
11	18JG5A0205	APSSDC	22/06/2020 to 04/07/2020
12	18JG5A0206	APSSDC	22/06/2020 to 04/07/2020
13	18JG5A0209	APSSDC	22/06/2020 to 04/07/2020

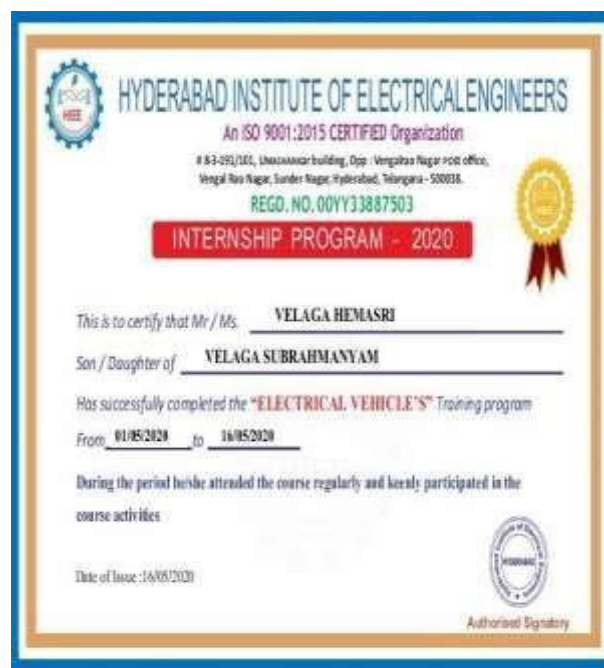

WORK SHOPS ATTENDED BY STUDENTS:

Sl .No	Name of Student	Workshop Attended	Event	Organization / Date	Prize
1	A.Varshini	1. Socure interpretibility 2. Circuit simulation and PCB design	SHASTRA,2020	IIT Madras, 3 rd & 4 th Jan ,2020	Participation
2	K.Jahnavi Krishna	1. Socure interpretibility 2. Circuit simulation and PCB design	SHASTRA,2020	IIT Madras, 3 rd & 4 th Jan ,2020	Participation
3	P.Saranya	1. Circuit Simulation and PCB design 2. Introduction to Aurdino	SHASTRA,2020	IIT Madras, 3 rd & 4 th Jan ,2020	Participation
4	S.Uma Maheswari	1. Circuit Simulation and PCB design 2. Introduction to Python and Machine Learning	SHASTRA,2020	IIT Madras, 3 rd & 4 th Jan ,2020	Participation
5	G.Prabha	1. Introduction to Aurdino 2. Circuit Simulation and PCB design	SHASTRA,2020	IIT Madras, 3 rd & 4 th Jan ,2020	Participation
6	G.Deepika	1. Introduction to Aurdino 2. Circuit Simulation and PCB design	SHASTRA,2020	IIT Madras, 3 rd & 4 th Jan ,2020	Participation
7	B.Sravani Selcia	1. Introduction to Aurdino 2. Circuit Simulation and PCB design	SHASTRA,2020	IIT Madras, 3 rd & 4 th Jan ,2020	Participation
8	J.Jahnavi	1. Introduction to Aurdino 2. Circuit Simulation and PCB design	SHASTRA,2020	IIT Madras, 3 rd & 4 th Jan ,2020	Participation
9	K.Varsha	1. Introduction to Aurdino 2. Circuit Simulation and PCB design	SHASTRA,2020	IIT Madras, 3 rd & 4 th Jan ,2020	Participation

SHORT STORY

The Group of Frogs
(Encouragement)

As a group of frogs was traveling through the woods, two of them fell into a deep pit. When the other frogs crowded around the pit and saw how deep it was, they told the two frogs that there was no hope left for them. However, the two frogs decided to ignore what the others were saying and they proceeded to try and jump out of the pit.

Despite their efforts, the group of frogs at the top of the pit were still saying that they should just give up. That they would never make it out. Eventually, one of the frogs took heed to what the others were saying and he gave up, falling down to his death. The other frog continued to jump as hard as he could. Again, the crowd of frogs yelled at him to stop the pain and just die. He jumped even harder and finally made it out. When he got out, the other frogs said, “**Did you not hear us?**” The frog explained to them that he was deaf. He thought they were encouraging him the entire time.

Moral of the story: People’s words can have a big effect on other’s lives. Think about what you say before it comes out of your mouth. It might just be the difference between life and death.

Puzzles:

- a) Billy's mother had five children. The first was named Lala, the second was named Lele, the third was named Lili, the fourth was named Lolo. What was the fifth child named?
- b) Choose the correct sentence: "the yolk of the egg is white" or "the yolk of the egg are white."
- c) It's as light as a feather, but the strongest person can't hold it for more than five minutes. What is it?
- d) The more there is, the less you see. What is it?
- e) What gets more wet while it dries?
- f) You can find it in Mercury, Earth, Mars, Jupiter and Saturn, but not in Venus or Neptune. What is it?
- g) It likes food, but water kills it. What is it?
- h) What's full of holes but can still hold water?
- i) Which is heavier, a pound of feathers or a pound of rocks?
- j) How far can a dog run into the woods?
- k) You're driving a city bus. At the first stop, three women get on. At the second stop, one woman gets off and a man gets on. At the third stop, two children get on. The bus is blue and it's raining outside in December. What color is the bus driver's hair?
- l) There are three houses. One is red, one is blue and one is white. If the red house is to the left of the house in the middle, and the blue house is to the right of the house in the middle, where's the white house?
- m) It's at the center of gravity and you can find it in Venus, but not Mars. What is it?
- n) What goes on four feet in the morning, two in the afternoon and three in the evening?
- o) What travels faster: heat or cold?
- p) A man was walking in the rain in the middle of nowhere without a coat or an umbrella. He got soaked, but not a single hair on his head was wet. How can this be?
- q) A cowboy rode into town on Friday. He stayed in town for three days and rode back out on Friday. How is this possible?

(by U.Ramya,17JG1A0231)

CROSSWORD

Work, Energy, and Power

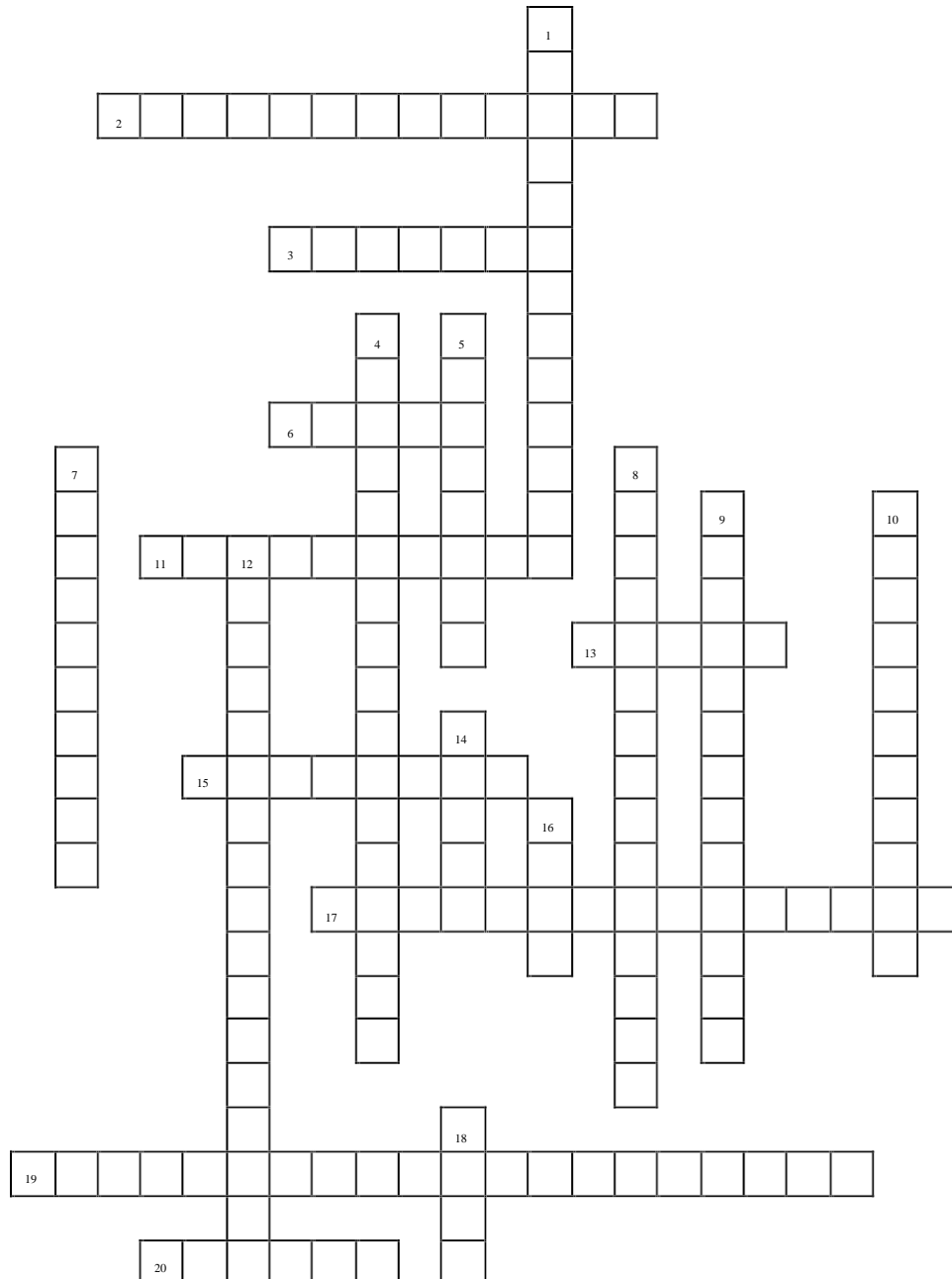

Across

2. form of energy involved in weighing fruit on a spring energy
3. a stretched rubber band or a stretched or compressed spring are examples of which potential energy
6. a push or pull
11. the sum of an object's potential and kinetic energy
13. work done in a certain amount of time
15. the force that opposes motion between two surfaces that are in contact

17. stored energy

19. states that energy cannot be created nor destroyed, but only transformed from one form into another

20. the ability to do work

Down

1. friction converts kinetic energy to

4. the net work done on an object is equal to its change in kinetic and potential energy

5. energy that is stored in chemical bonds

7. a roller coaster track is an example of a

8. friction and air resistance is an example of what type of force

9. energy of a moving object

10. the sum of kinetic energy and all forms of potential energy

12. the gravitation force is called a

14. SI unit of work

16. the unit of power equal to one joule of energy transferred in one second

18. the product of the force exerted on an object and the distance the object moves in the direction of the force

(by U.Ramya,17JG1A0231)

VOCABULARY

VOCABULARY – NEW ENGLISH WORDS (with meanings)

Sl.No	Word	Meaning	Usage
1	Toil	Work extremely hard or incessantly	He <i>toil</i> to get into IIT's
2	Heed	Pay attention to	If he heard, he paid no <i>heed</i>
3	Ambiguity	Uncertainty or doubtfulness	The <i>ambiguity</i> begin to disappear when more explanations are made
4	Pristine	A state of being like new	The car is 20 yrs old but it is still <i>pristine</i> .
5	Exuberant	Full of energy	She gave an <i>exuberant</i> performance.
6	Optimisation	The action of making the best	That's all you need to <i>optimize</i> agriculture.
7	Benevolent	Willing to help	She was a <i>benevolent</i> women
8	Drool worthy	Attractive or desirable extremely	He is always an interesting man, he is even more <i>drool worthy</i>
9	Facepalm	To hide face with palm as an expression of embarrassment	They facepalmed as they lose in finals
10	Totes	Totally (in informal form)	The scenery is <i>totes</i> amazing
11	Unfettered	Not bound by shackles	<i>Unfettered</i> by bounds , my imagination flourished
12	Render	Provide or give	Money serves as a reward for the services <i>rendered</i>
13	Ascend	To go up; to move upward	They watched their balloons slowly <i>ascending</i> into the sky
14	Extravagant	Spending too much money	The couple lived a simple life with no <i>extravagant</i> purchases
15	Venture	Proceed somewhere despite the risk of danger.	He nervously <i>ventured</i> out the ice.
16	Vindictive	Showing strong desire for revenge.	She smiles, but in a <i>vindictive</i> way
17	Blunder	Careless mistake	She stopped finally realizing the <i>blunder</i> mistake she has made.

18	Accord	Occurrence of opinion	The committee worked in <i>accord</i> with bill.
19	Deprive	Prevent from using (or) having something	She was <i>deprived</i> of her royal privilege
20	Milady	Noble women	Good morning, <i>Milady</i> .
21	Inept	Unskilful	She is totally <i>inept</i> at dealing with people.
22	Vape	To give up smoking in favour of electronics.	For the sake of his health he gives up smoking and tries <i>vaping</i> .
23	Accidial	To dial some one's number accidentally	I was trying to dial mona , but I <i>accidial</i> Monika
24	Be dunged	To be old or old fashioned	The artists with their <i>be dunged</i> mannequins lost in competition
25	Binge watch	Watch multiple episodes of TV program in rapid succession	I'm currently <i>binge watching</i> all the episodes of Super natural
26	Conlang	An invented language intended for human communication.	He was a <i>conlang</i> expert, who invented 'Dothraki' for Game of thrones.
27	Crunk	Very excited, full of energy	The guys there get <i>crunk</i> with some raw hip hop.
28	Ginger	A person with red hair	Some, call john <i>ginger</i> because of his red hair.
29	Hanger	Anger because of hunger	People often <i>hangry</i> , when the sugar level in their blood is low.
30	Kadult	A person who is technically an adult but acts as kid.	I can say my 23 year old brother a <i>kadult</i> .
31	Meh	Uninspiring; impressed about something.	I ordered a new dress online, but when I tried it on <i>meh</i> .
32	Muggle	A person who don't have a particular type of skill or talent	When it comes to cooking and cleaning she is completely a <i>muggle</i> .
33	Buko	A person who is under 5 ft tall and angry.	No one dares to involve him, he is a <i>buko</i>

34	Buzz kill	A person or thing that has a depressing effect	Hearing how fattening this food will be a <i>buzzkill</i>
35	Usie	A group selfie	Come on let's have a usie
36	Weak sauce	Extremely bad or disappointing	The design is <i>weak sauce</i>
37	Geggie	A person's mouth	Shut your <i>geggie</i>
38	Yowza	Used to express excitement	<i>Yowza !</i> Mom has arrived!
39	Sproglet	A baby or small child	The <i>sproglet</i> she's holding is very cute
40	Spret	To tera, split and burst	She <i>spret</i> the book in anger

CONTRIBUTIONS & ACHIVEMENTS

Few of our students have been placed in various companies like INFOSYS, TCS, WIPRO, and many more.

Students selected for Campus Placements:

S. No	Name	Roll No	Company
1	A.V.S.SINDHURI	17JG1A0201	TCS
2	K.V.V.SUSHMA	17JG1A0214	WIPRO
3	S.UMA MAHESWARI	17JG1A0227	WIPRO & INFOSYS
4	S.POOJITHA VANI	17JG1A0228	WIPRO & TCS
5	U.RAMYA	17JG1A0231	WIPRO
6	K.JAHNAVI KRISHNA	17JG1A0236	WIPRO



NPTEL CERTIFICATIONS:

IV- YEAR:

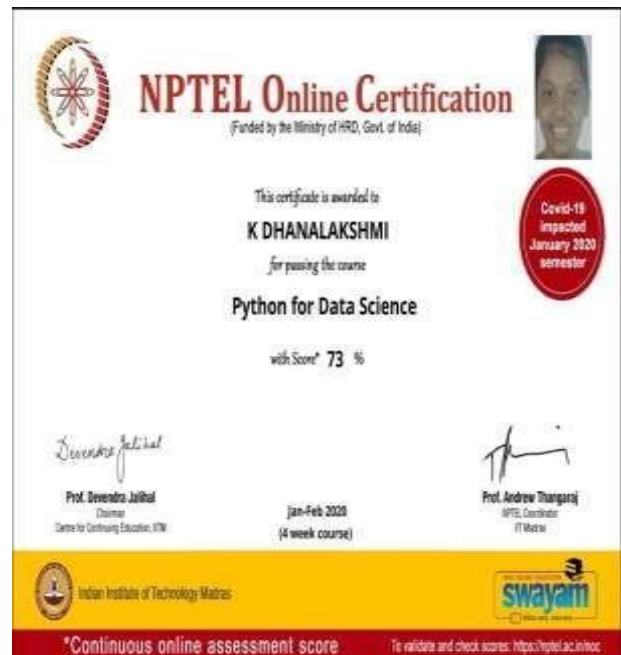
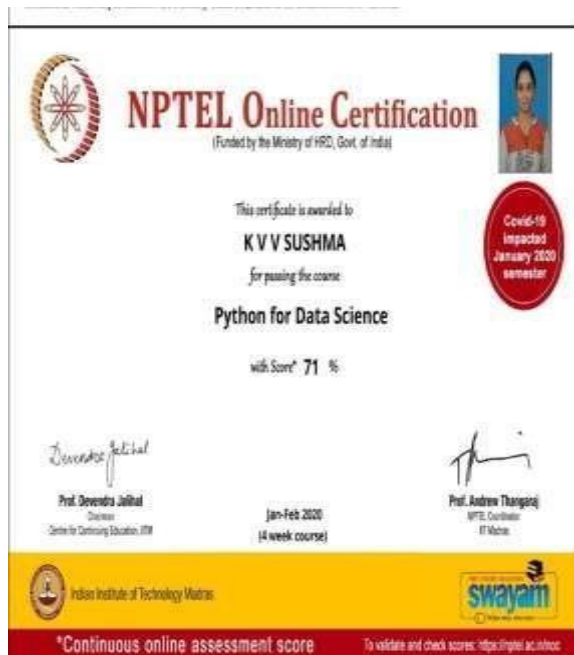

ARTS:



-by M.Suneeta
(18JG5A0206)



- by G. Sai Keerthi
(19JG1A0213)



-by P.Swayam Prabha
(17JG1A0224)



- by L.BHAVANA
(18JG1A0216)

CAREER GUIDANCE

TOP UNIVERSITIES

- Massachusetts Institute of Technology
- Stanford University
- Harvard University
- The University of California, Berkeley (UCB)

TOP JOB SEEKERS WEBSITES

- Monster
- Naukri
- TimesJobs
- Fresher world
- LinkedIn

CERTIFICATION COURSES

- Coursera
- Edx
- MOOC
- NPTEL
- ARPIT

INTERNSHIP UNDER

- HIEEE
- APSSDC
- NTPC
- APTRANSCO
- APEPDCL
- Vizag Steel Plant
- Coromandel Fertilizers
- HPCL
- BHEL
- Hindustan Shipyard
- CEMS

STUDENT MEMBERSHIP:

- IEEE Xplore
- ISTE

With a degree in Electrical and Electronics Engineering, you can find work in a wide range of sectors including aerospace , automotives , energy, IT and telecommunications.

EDITORIAL TEAM

Dr.R.V.S.Lakshmi Kumar	: Head Of The Department , EEE Dept.
Mrs. V.Sree Vidhya	: Assistant Professor, Department of EEE
U. Ramya	: 17JG1A0231
John Mercy	: 18JG1A0229
G.Ramya Likhitha	: 18JG1A0204
P.Sujitha	: 18JG1A0222

For Any Suggestions Mail to : eeemagazine@gvpcew.ac.in